

DIGITAL REMOTE STARTER / CAN ALARM WITH REMOTE TRANSMITTER KIT
DÉMARREUR À DISTANCE DIGITAL / ALARME CAN AVEC ENSEMBLE DE TÉLÉCOMMANDES
GUIDE #69291

- CAUTION, THIS UNIT IS NOT COMPATIBLE WITH ALL VEHICLES: SEE VEHICLE FIT GUIDE AT : http://fortin.ca/en/features/stand_alone_remote_starter.html
- REMOTE STARTER ONLY COMPATIBLE WITH AUTOMATIC TRANSMISSION VEHICLES.
- CETTE ENSEMBLE NE CONVIENT PAS À TOUS LES VÉHICULES: VOIR LA LISTE DES VÉHICULES SUPPORTÉS AU : http://fortin.ca/fr/features/stand_alone_remote_starter.html
- DÉMARREUR À DISTANCE COMPATIBLE AVEC VÉHICULE À TRANSMISSION AUTOMATIQUE SEULEMENT.

PARTS INCLUDED | PIÈCES INCLUSES

1x EVO-ALL

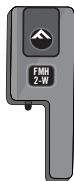

1x ANT-FMH-2W



2x RM411

4x Cable (1x 5pins, 1x 4pins, 1x 5pins red, 1x 20pins)	4x Câbles (1x 5pins, 1x 4pins, 1x 5pins rouge, 1x 20pins)
1x RFA2A Cable	1x Câble RFA2A
1x Wirecolor card	1x Carte wirecolor
1x RM411 User guide	1x Guide utilisateur RM411
1x Warning label	1x Autocollant d'avertissement
1x Antenna Câble	1x Câble d'antenne
1x Hood pin	1x Contact de capot
1x Valet switch	1x Commutateur valet

PARTS REQUIRED (NOT INCLUDED) | PIÈCES REQUISES (NON INCLUSES)

1x Microsoft Windows Computer (Internet connection required)

1x Ordinateur Microsoft Windows (connection Internet requise)

1x Flash Link Updater

1x Flash Link Updater



See vehicle individual guide for more information on parts required



Voir le guide individuel du véhicule pour connaître les pièces requises.









INFORMATIONS
www.fortin.ca

 Technical support: TEL: 514-255-4357
 1-877-336-7797

Guide version : 20170911

Copyright © 2017 / FORTIN AUTO RADIO INC / ALL RIGHTS RESERVED / MADE IN CANADA

CHOOSE YOUR INSTALLATION TYPE | CHOISIR SON MODE D'INSTALLATION

REMOTE STARTER		DÉMARREUR À DISTANCE	
 Stand Alone Installation for Automatic Transmission only OR  Stand Alone Installation with T-harness for Automatic Transmission only	 Installation stand alone pour transmission automatique seulement OU  Installation stand alone avec Harnais en T pour transmission automatique seulement	ALARM Installation with remote starter installation for <u>Automatic Transmission only.</u> OR Installation without remote starter installation.	ALARME Installation avec démarreur à distance pour <u>transmission automatique seulement.</u> OU Installation sans démarreur à distance.
			
DOWNLOAD SPECIFIC VEHICLE INSTALL GUIDE AT WWW.FORTIN.CA	TÉLÉCHARGEZ LE GUIDE SPÉCIFIQUE AU VÉHICULE AU WWW.FORTIN.CA	DOWNLOAD GUIDE # 16221 AT WWW.FORTIN.CA	TÉLÉCHARGEZ LE GUIDE # 16221 AU WWW.FORTIN.CA

TRANSMITTER KIT PROGRAMMING | PROGRAMMATION ENSEMBLE DE TÉLÉCOMMANDES

	Program bypass option: Programmez l'option du contournement:	UNIT OPTION OPTION UNITE	DESCRIPTION
		H2	Supported RF KITS: FORTIN2 Kits RF support: FORTIN2

CONNECTION GUIDE WITH T-HARNESS | GUIDE DE CONNECTION AVEC T-HARNAIS

DOWNLOAD THE COMPLETE VEHICLE INSTALL GUIDE AT WWW.FORTIN.CA FOR THE OTHER NECESSARY CONNECTIONS. THE EVO-ALL MUST BE CONNECTED AND PROGRAMMED TO THE VEHICLE.

TÉLÉCHARGEZ LE GUIDE D'INSTALLATION COMPLET DU VÉHICULE AU WWW.FORTIN.CA POUR LES AUTRES BRANCHEMENTS REQUIS. LE EVO-ALL DOIT ÊTRE BRANCHÉ ET PROGRAMMÉ AU VÉHICULE.

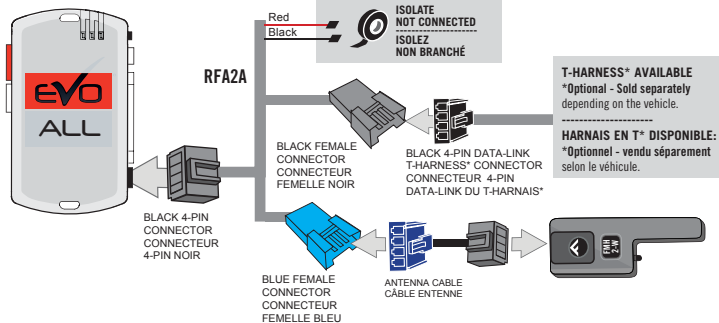







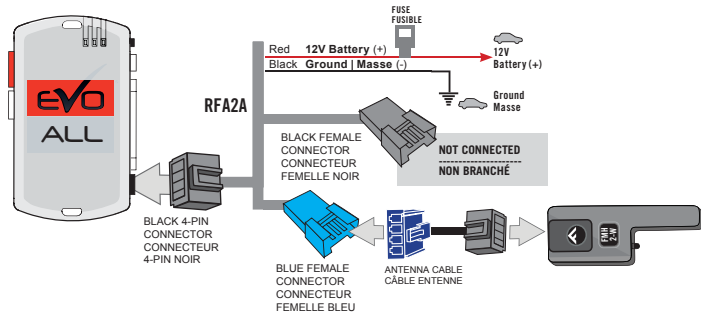

CONNECTION GUIDE WITHOUT T-HARNESS | GUIDE DE CONNECTION SANS T-HARNAIS

DOWNLOAD THE COMPLETE VEHICLE INSTALL GUIDE AT WWW.FORTIN.CA FOR THE OTHER NECESSARY CONNECTIONS. THE EVO-ALL MUST BE CONNECTED AND PROGRAMMED TO THE VEHICLE.

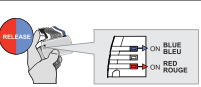
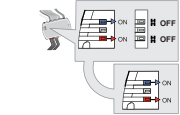
TÉLÉCHARGEZ LE GUIDE D'INSTALLATION COMPLET DU VÉHICULE AU WWW.FORTIN.CA POUR LES AUTRES BRANCHEMENTS REQUIS. LE EVO-ALL DOIT ÊTRE BRANCHÉ ET PROGRAMMÉ AU VÉHICULE.

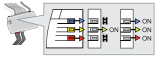

PROGRAMMING REMOTE TRANSMITTER(S) | PROGRAMMATION DES TÉLÉCOMMANDES

<p>1</p> 	<p>Unplug the 4 Pin (Data-Link) connector.</p>	<p>Débranchez le connecteur 4 pins (Data-Link).</p>
<p>2</p> 	<p>Press and hold the programming button: Reinsert the 4-Pin (Data-Link) connector.</p>	<p>Appuyez et maintenir enfoncé le bouton de programmation: Insérez le connecteur 4 pins (Data-Link)</p>
<p>3</p> 	<p>Release the programming button when LEDs are BLUE & RED.</p> <p><i>If the LED are not solid BLUE and RED disconnect the 4-Pin connector (Data-Link) and go back to step 1.</i></p>	<p>Relâchez le bouton de programmation quand les DELs sont BLEU et ROUGE sont allumées.</p> <p><i>Si les LED ne sont pas ALLUMÉES BLEU et ROUGE, débranchez le connecteur 4 pins (Data-Link) et allez au début de l'étape 1.</i></p>
<p>4</p> 	<p>Press and hold the programming button until the Blue and RED LED turn back ON.</p> <p><i>The Blue and Red LED will go Off and back On.</i></p>	<p>Pesez et gardez appuyé le bouton de programmation jusqu'à ce que les DELS BLEU et ROUGE se rallument.</p> <p><i>Les DELS BLEU et ROUGE s'éteignent et se rallument.</i></p>
<p>5</p> 	<p>Turn the key to the ON/RUN position. The Blue, Yellow and Red LEDs will turn On. The antenna will flash rapidly.</p>	<p>Tournez la clé à la position ON/RUN. Les DELS BLEU, JAUNE et ROUGE s'allument. L'antenne clignote rapidement.</p>
<p>6</p> <p>RIM411</p> 	<p>On each Transmitter Press and HOLD the  for 12 SECONDS and WAIT for the LED to TURN ON SOLID then release.</p>	<p>SUR CHACUNE DES TÉLÉCOMMANDES: Appuyez et tenez enfoncé le  pour 12 SECONDES et attendez que la Del S'ALLUME SOLIDE, ensuite relâchez.</p>
	<p>The Blue and Red LEDs will flash once everytime to confirm.</p>	<p>Les DELS BLEU et ROUGE clignoteront une fois chaque fois pour confirmer.</p>
<p>7</p> 	<p>Turn the Ignition to the OFF position and test the installation.</p>	<p>Tournez la clé à OFF et testez l'installation.</p>
<p>The remote is now programmed.</p>		<p>La télécommande est maintenant programmée.</p>

WARNING | MISE EN GARDE

REMOTE STARTER INSTALLATION ONLY COMPATIBLE WITH AUTOMATIC TRANSMISSION VEHICLES.

SEE VEHICLE FIT GUIDE AT :
http://fortin.ca/en/features/stand_alone_remote_starter.html

Neither the manufacturer or distributor of this module is responsible for damages of any kind either indirectly or directly caused by this module, except for the replacement of this module in case of manufacturing defects. This module must be installed by a qualified technician. This instruction guide may change without notice. Visit www.fortin.ca to obtain the latest version.

INSTALLATION DU DÉMARREUR À DISTANCE COMPATIBLE AVEC VÉHICULE À TRANSMISSION AUTOMATIQUE SEULEMENT.

VOIR LA LISTE DES VÉHICULES
SUPPORTÉS AU : http://fortin.ca/fr/features/stand_alone_remote_starter.html

Ni le manufacturier, ni le distributeur ne se considèrent responsables des dommages causés ou ayant pu être causés, indirectement ou directement, par ce module, excepté le remplacement de ce module en cas de défaut de fabrication. Ce module doit être installé par un technicien qualifié. Ce guide d'instruction peut faire l'objet de changement sans préavis. Consultez le www.fortin.ca pour voir la plus récente version.