



**REGULAR & THAR-FOR2 INSTALLATION  
INSTALLATION RÉGULIÈRE ET THAR-FOR2**
**ADDENDUM - SUGGESTED WIRING CONFIGURATION  
ADDENDA - SCHÉMA DE BRANCHEMENT SUGGÉRÉ**

		Vehicle functions supported in this diagram (functional if equipped)   Fonctions du véhicule supportées dans ce diagramme (fonctionnelles si équipé)																
VEHICLE VEHICULES	YEARS ANNÉES	Immobilizer bypass Contournement d'immobilisateur	T-Harness available (sold separately) Harnais en T disponible (vendu séparément)	Lock	Unlock	Arm	Disarm	RAP Disable	Trunk Release	Parking Lights	Tachometer	Door Status	Trunk Status	Hood Status*	Hand-Brake Status	Foot-Brake Status	OEM Remote monitoring	
	Fusion	2013	•	•	•	•	•	•	•	•	•	•	•	•	•	•	•	•
	Hybrid	2013	•	•	•	•	•	•	•	•	•	•	•	•	•	•	•	•



FIRMWARE VERSION  
VERSION LOGICIELLE

## 71.[55]

MINIMUM

To add the firmware version and the options, use the **FLASH LINK UPDATER** or **FLASH LINK MOBILE** tool, sold separately.  
Pour ajouter la version logicielle et les options, utilisez l'outil **FLASH LINK UPDATER** ou **FLASH LINK MOBILE**, vendu séparément.

	UNIT OPTION OPTION UNITE	DESCRIPTION
	<b>Program bypass option: Programmez l'option du contournement:</b>	
	<b>C1</b>	OEM Remote status (Lock/Unlock) monitoring Suivi des status (Verrouillage/Déverrouillage) de la télécommande d'origine

<b>IF THE VEHICLE IS NOT EQUIPPED WITH FUNCTIONAL HOOD PIN: SI LE VÉHICULE N'EST PAS ÉQUIPÉ D'UN CONTACT DE CAPOT FONCTIONNEL:</b>	<b>A11</b>	<b>OFF NON</b>	Hood trigger (Output Status). Contact de capot (état de sortie).
--	------------	--------------------	---

	UNIT OPTION OPTION UNITE	DESCRIPTION
	<b>Program bypass option (Vehicle hybrid only): Programmez l'option du contournement (vehicule hybride seulement):</b>	
	<b>D4</b>	Hybrid mode (Vehicle hybrid only) Mode hybride (vehicule hybride seulement)

<b>E5</b>	<b>ON OUI</b>	<b>Feature 2.</b> <b>Fonction 2.</b>
-----------	-------------------	---

	UNIT OPTION OPTION UNITE	DESCRIPTION
	<b>Program bypass option (If this option is not OFF the Ignition will turn On when the door are unlock): Programmez l'option du contournement (si cette option n'est pas à NON l'ignition s'allumera lorsque le véhicule est déverrouillé):</b>	
	<b>A5</b>	<b>OFF NON</b>
		AUX.1 AUX.1

MANDATORY INSTALL   INSTALLATION OBLIGATOIRE			
<p><b>*HOOD PIN</b></p> <p><b>CONTACT DE CAPOT</b></p> 	<p><b>HOOD STATUS:</b> THE HOOD PIN SWITCH MUST BE INSTALLED IF THE VEHICLE CAN BE REMOTE STARTED WITH THE HOOD OPEN, SET FUNCTION A11 TO OFF.</p> <p><b>STATUT DE CAPOT:</b> LE CONTACT DE CAPOT, DOIT ÊTRE INSTALLÉ SI LE VÉHICULE PEUT DÉMARRER À DISTANCE, LORSQUE LE CAPOT EST OUVERT, PROGRAMMEZ LA FONCTION A11 À NON.</p>	<b>A11</b>	<b>OFF NON</b>
<p><b>Notice:</b> the installation of safety elements are mandatory. The hood pin is an essential security element and must be installed.</p> <p><b>Notice:</b> l'installation des éléments de sécurité est obligatoire. Le contact de capot est un élément de sécurité essentiel et doit absolument être installé.</p>		<p>THIS MODULE MUST BE INSTALLED BY A QUALIFIED TECHNICIAN. A WRONG CONNECTION CAN CAUSE PERMANENT DAMAGE TO THE VEHICLE.</p> <p>CE MODULE DOIT ÊTRE INSTALLÉ PAR UN TECHNICIEN QUALIFIÉ, TOUTE ERREUR DANS LES BRANCHEMENTS PEUT OCCASIONNER DES DOMMAGES PERMANENTS AU VÉHICULE.</p>	

DESCRIPTION | DESCRIPTION

		Parts required (Not included)	Pièce(s) requise(s) (Non incluse(s))	PAGE
--	--	-------------------------------	--------------------------------------	------

WIRE TO WIRE DIAGRAM | SCHÉMA DE BRANCHEMENTS FIL À FIL

	2x	Vehicle key for programming	Clés du véhicule pour la programmation	Page 3
	2x	Diode 1Amp	Diodes 1Amp	
	1x	Relay (key Bypass)	Relais (contournement de clé)	
	1x	Relay (Parking lights)	Relais (Feux de stationnement)	

THARNESS DIAGRAM | SCHÉMA DE BRANCHEMENTS HARNAIS EN T

THARNESS THAR-FOR2	1x	THAR-FOR2	THAR-FOR2	Page 4
	2x	Vehicle key for programming	Clés du véhicule pour la programmation	
	1x	Relay (Parking lights)	Relais (Feux de stationnement)	

⑥ Trunk release switch on the dash  
Commutateur d'ouverture de valise dans le tableau de bord.

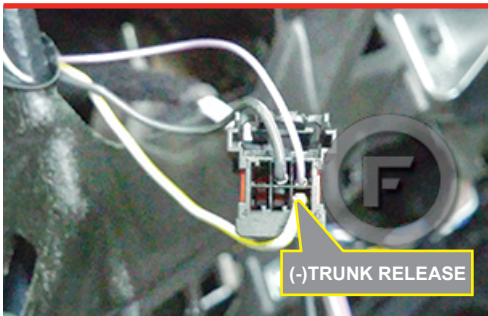

④ Parking Lights switch  
Commutateur des feux de stationnement

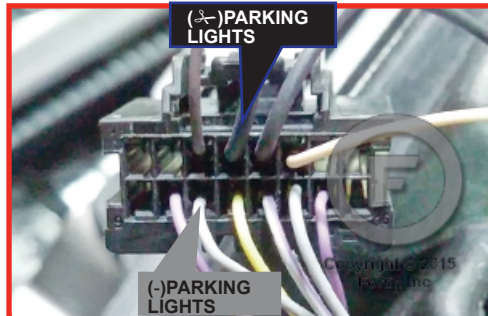

⑤ Behind OBD-II connector  
left side of steering column.  
Derrière le connecteur OBD-II  
situé à gauche de la colonne de direction.

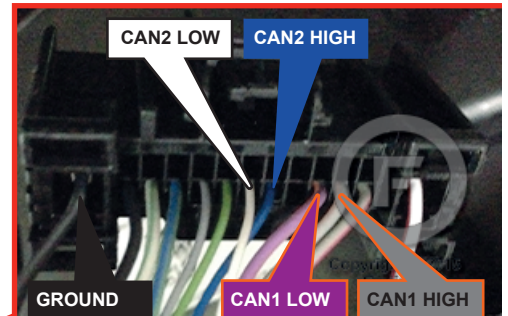

① ② Ignition barrel  
Barillet d'ignition

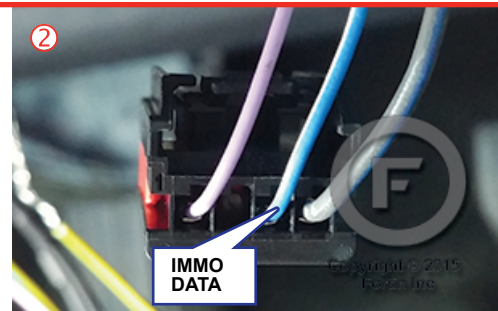
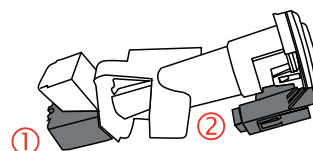
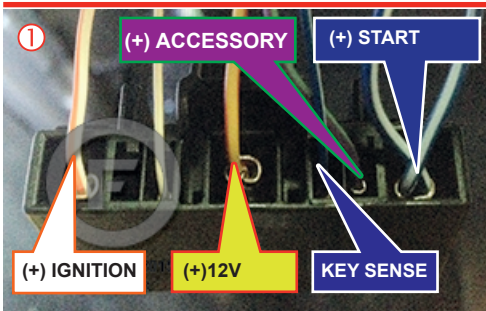

WIRING CONNECTION | GUIDE DE BRANCHEMENTS

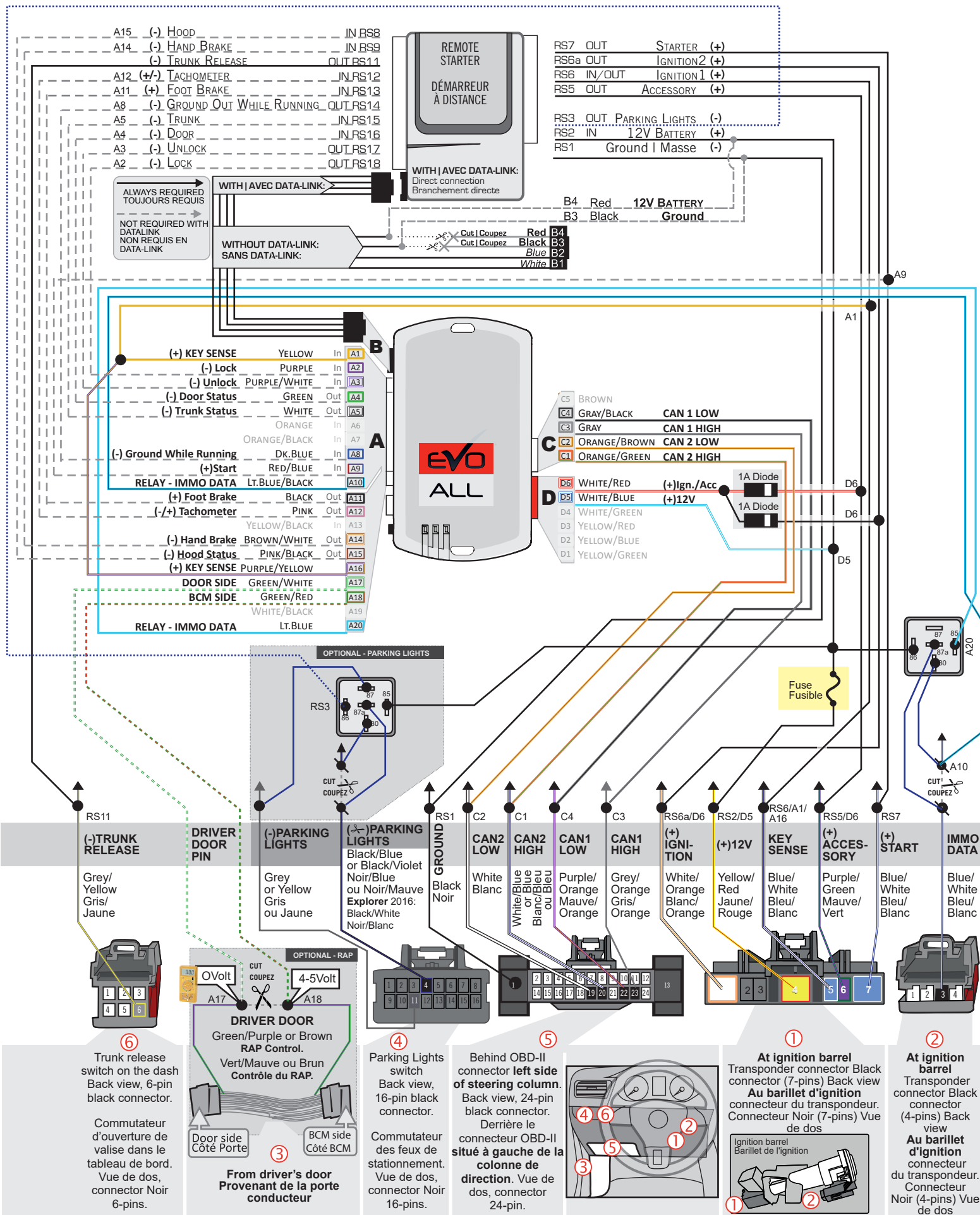

THAR-FOR2 | WIRING CONNECTION | GUIDE DE BRANCHEMENTS

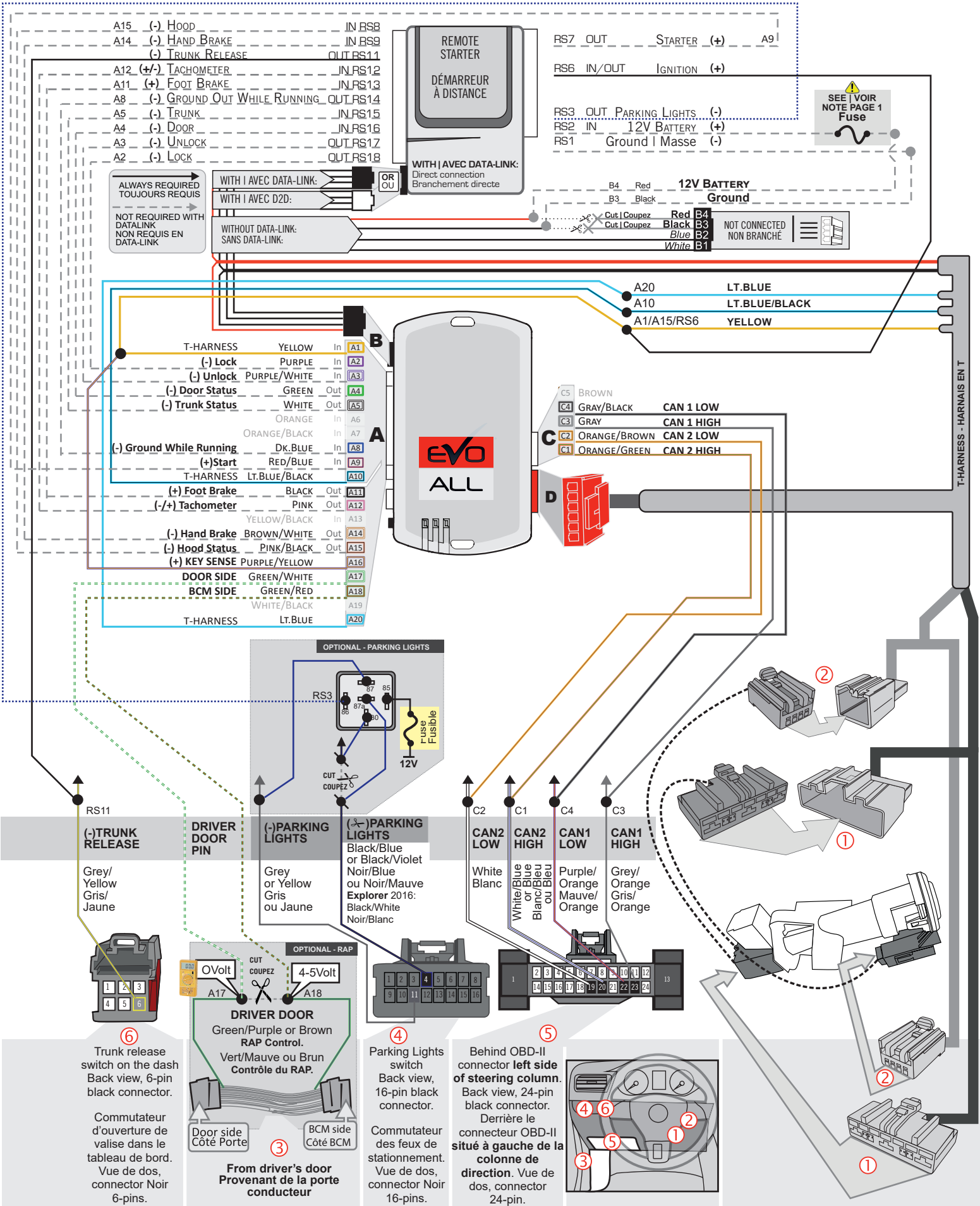

⑥ Trunk release switch on the dash Back view, 6-pin black connector.  
Commutateur d'ouverture de valise dans le tableau de bord. Vue de dos, connector Noir 6-pins.

③ From driver's door Provenant de la porte conducteur

④ Parking Lights switch Back view, 16-pin black connector.  
Commutateur des feux de stationnement. Vue de dos, connector Noir 16-pins.

⑤ Behind OBD-II connector left side of steering column. Back view, 24-pin black connector. Derrière le connecteur OBD-II situé à gauche de la colonne de direction. Vue de dos, connector 24-pins.

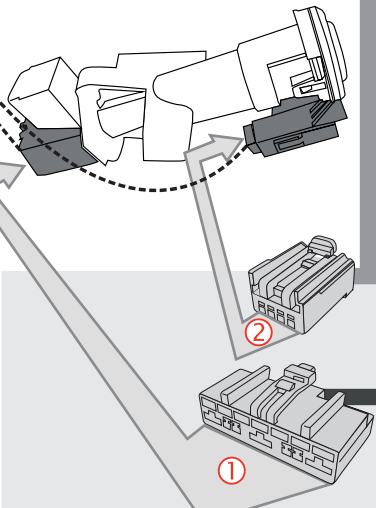
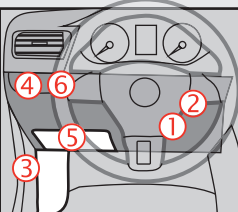



**DCRYPTOR PROGRAMMING PROCEDURE | PROCÉDURE DE PROGRAMMATION AVEC DCRYPTOR**



Parts required (not included)

- 1x **FLASH LINK UPDATER,**
- 1x **FLASH LINK MANAGER**  
SOFTWARE | PROGRAMME
- 1x Microsoft Windows Computer with Internet connection  
Ordinateur Microsoft Windows avec connection Internet

Pièces requises (non incluses)

- 1x **FLASH LINK MOBILE**
- 1x **FLASH LINK MOBILE APP**
- Smartphone *Android* or *iOS* with Internet connection  
(Internet provider charges may apply)  
Téléphone Intelligent *Android* ou *iOS* avec connection Internet  
(des frais du fournisseur Internet peuvent s'appliquer)

OR  
OU



**BEFORE PROGRAMMING SET THE UNIT OPTIONS AND SAVE. | AVANT LA PROGRAMMATION CONFIGURER LES OPTIONS DE L'UNITÉ ET SAUVEGARDER.**

1

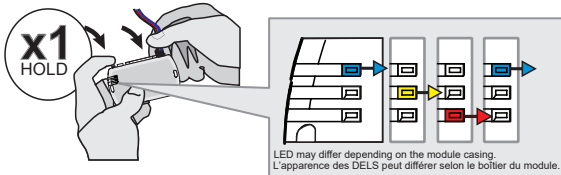

**Press and hold** the programming button:  
**Insert** the 4-Pin (Data-Link) connector.

↳ The Blue, Red, Yellow and Blue & Red LED's will alternatively illuminate.

**Appuyez et maintenez enfoncé** le bouton de programmation:  
**Insérez** le connecteur 4 pins (Data-Link)

↳ Les DELs Bleue, Rouge, Jaune et Bleue & Rouge s'allumeront alternativement.

2

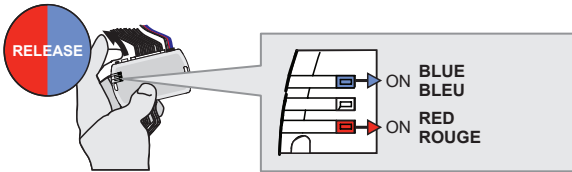

**Release** the programming button when the LED's are RED and BLUE.

*If the LED's are not solid BLUE and RED disconnect the 4-Pin connector (Data-Link) and go back to step 1.*

**Relâchez** le bouton de programmation quand les DELS sont ROUGE et BLEU.

*Si les DELs ne sont pas BLEU et ROUGE débranchez le connecteur 4 pins (Data-Link) et allez au début de l'étape 1.*

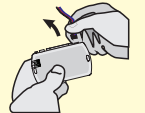

3

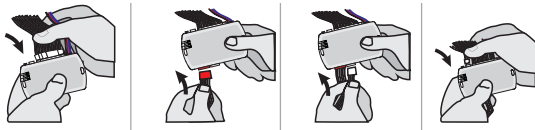

**Insert** the required remaining connectors.

**Insérez** les connecteurs requis restants.

4

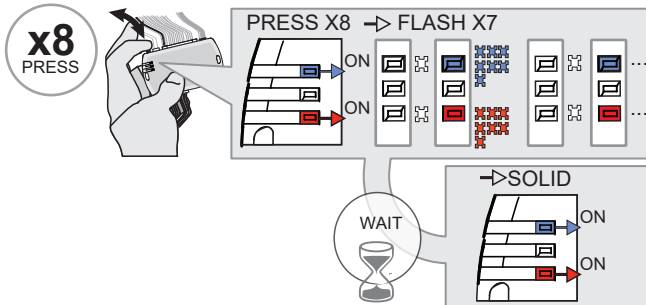

**Press and release** the programming button eight (8x) times.

↳ The RED and BLUE LED's will alternate between 7 flashes and a pause.

**Wait,**

↳ The RED and BLUE LED's will turn ON solid.

**Appuyez et relâchez** 8 fois le bouton de programmation.

↳ Les DELs ROUGE et BLEU alterneront entre 7 clignotements et une pause.

**Attendez,**

↳ Les DELs ROUGE et BLEU resteront allumées solide.

5

**KEY #1  
CLÉ #1**

**WITH FLIP KEY | AVEC CLÉ FLIP**

**Flip** the key blade inside the key.  
**Rentrez** la lame de la clé à l'intérieur de la clé.

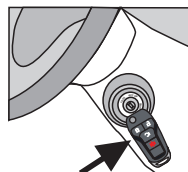

**Place** the key #1 in front of the ignition barrel.  
**Placez** la clé #1 devant le barillet d'ignition.

**WITHOUT FLIP KEY | SANS CLÉ FLIP**

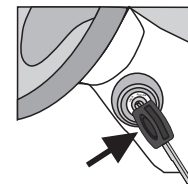

**Place** the back of the key #1 in front of the ignition barrel.  
**Placez** le dos de la clé #1 devant le barillet d'ignition.

**KEY BYPASS PROGRAMMING PROCEDURE 2/4 | PROCÉDURE DE PROGRAMMATION CONTOURNEMENT DE CLÉ 2/4**

6

**KEY #1  
CLÉ #1**

**x1  
PRESS**

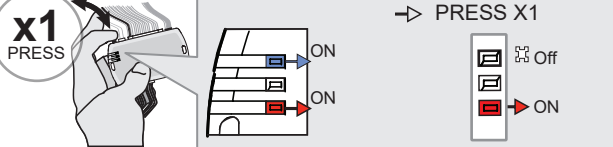

**Press and release the programming button once.**

↳ The BLUE LED will turn OFF.

**Appuyez et relâchez 1 fois le bouton de programmation.**

↳ La DEL BLEU s'éteindra.

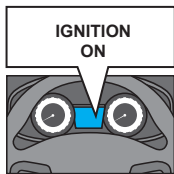

WAIT

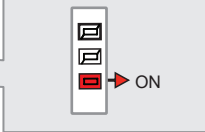

The vehicle's ignition will turn ON.

↳ The RED LED will stay ON.

L'ignition du véhicule s'allumera.

↳ La DEL ROUGE restera allumée.

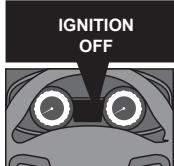

WAIT

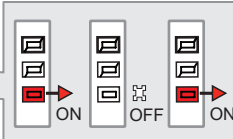

The vehicle's ignition will turn OFF.

↳ The RED LED will turn OFF then ON solid.

L'ignition du véhicule s'éteindra.

↳ La DEL ROUGE s'éteindra et se rallumera.

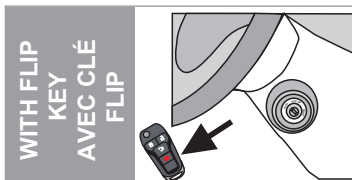

WITH FLIP KEY  
AVEC CLÉ FLIP

**Remove the key #1.  
Retirez la clé #1.**

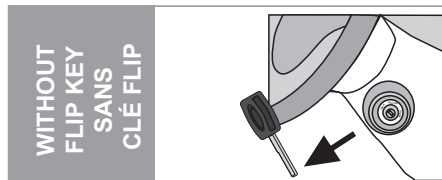

WITHOUT FLIP KEY  
SANS CLÉ FLIP

**Remove the key #1.  
Retirez la clé #1.**



Wait, 3 seconds.

Attendre 3 secondes.

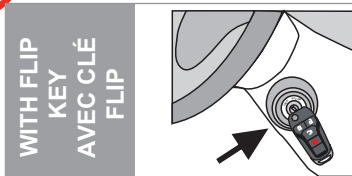

WITH FLIP KEY  
AVEC CLÉ FLIP

**Place the key #2 in front of the ignition barrel.  
Placez la clé #2 devant le barillet d'ignition.**

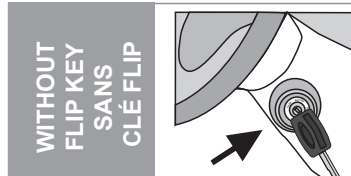

WITHOUT FLIP KEY  
SANS CLÉ FLIP

**Place the back of the key #2 in front of the ignition barrel.  
Placez le dos de la clé #2 devant le barillet d'ignition.**

7

**KEY #2  
CLÉ #2**

**x1  
PRESS**

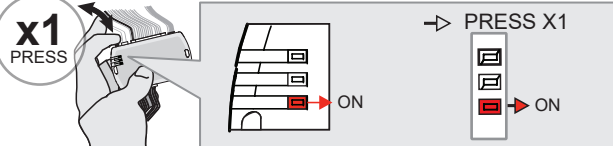

**Press and release the programming button once.**

↳ The YELLOW LED will turn ON solid.

**Appuyez et relâchez 1 fois le bouton de programmation.**

↳ La DEL JAUNE s'allumera solide.

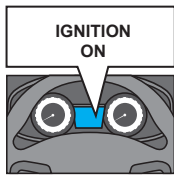

WAIT

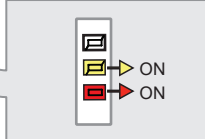

The vehicle's ignition will turn ON.

L'ignition du véhicule s'allumera.

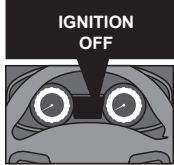

WAIT

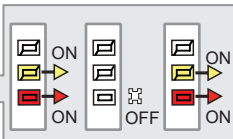

The vehicle's ignition will turn OFF.

↳ The RED and YELLOW LED's will turn OFF then ON solid.

L'ignition du véhicule s'éteindra.

↳ Les DELs ROUGE et JAUNE s'éteindront et se rallumeront solide.

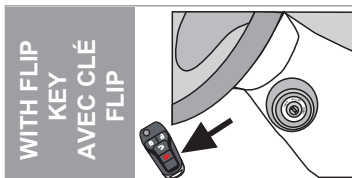

WITH FLIP KEY  
AVEC CLÉ FLIP

**Remove the key #2.  
Retirez la clé #2.**

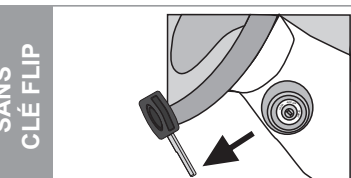

WITHOUT FLIP KEY  
SANS CLÉ FLIP

**Remove the key #2.  
Retirez la clé #2.**

**KEY BYPASS PROGRAMMING PROCEDURE 3/4 | PROCÉDURE DE PROGRAMMATION CONTOURNEMENT DE CLÉ 3/4**

8

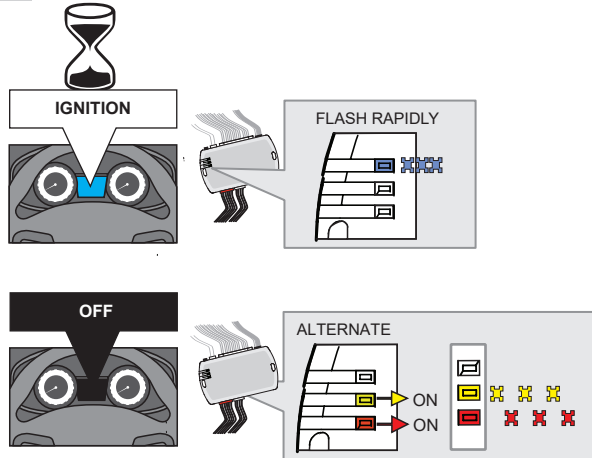

**Wait,**

The vehicle's ignition will turn ON.

↳ The BLUE LED will flash rapidly.

**Attendre,**

L'ignition du véhicule s'allumera.

↳ La DEL BLEUE clignotera rapidement.

The vehicle's ignition will turn OFF.

↳ The RED and YELLOW LED's will alternate.

L'ignition du véhicule s'éteindra.

↳ La DEL ROUGE et JAUNE alterneront.

9

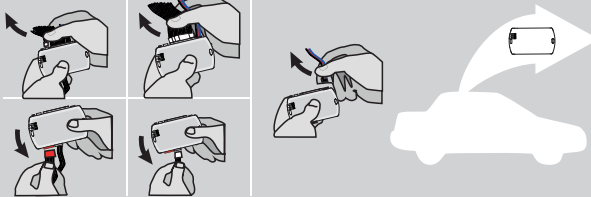

**Disconnect** all the connectors and after the Data-Link (4-pins) connector.

**Débranchez** tous les connecteurs et ensuite le connecteur Data-Link (4-pins).

10

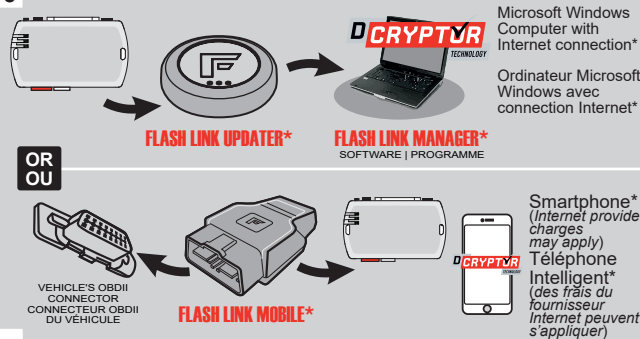

**Use** the tool: FLASH LINK UPDATER or FLASH LINK MOBILE to visit the DCRYPTOR menu.

**Utilisez** l'outil: FLASH LINK UPDATER ou FLASH LINK MOBILE pour visiter le menu DCRYPTOR.

\*Parts required (not included) \*Pièces requises (non incluses)

11

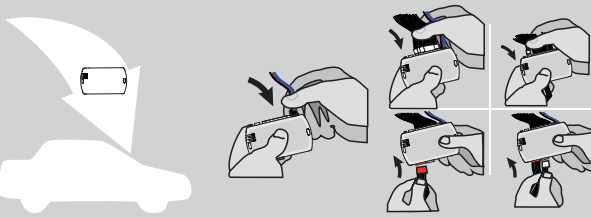

**AFTER DCRYPTOR PROGRAMMING COMPLETED** Go back to the vehicle and **reconnect** the 4-Pin (Data-Link) connector and after, all the remaining connector.

**APRÈS LA PROCÉDURE DE PROGRAMMATION DCRYPTOR COMPLÉTÉE :** retournez au véhicule et **rebranchez** le connecteur 4-pins (Data-Link) et après, tous les connecteurs du EVO-ALL.

12

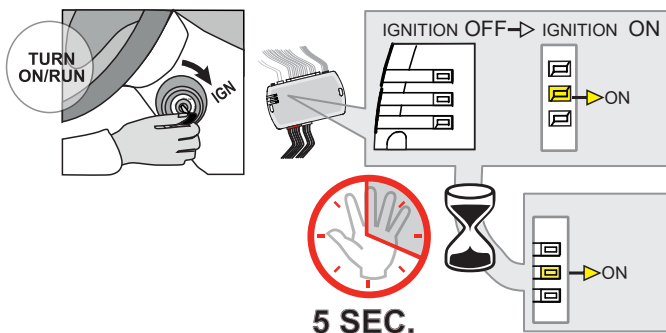

**Turn** the key to the Ignition ON/RUN position.

**Tournez** la clé à Ignition.

↳ The YELLOW LED will turn ON.

↳ La DEL JAUNE s'allume solide.

**Wait**, at least 5 seconds, do not disconnect the modules or turn off the ignition.

**Attendre**, peut prendre jusqu'à 5 secondes, ne pas débrancher le module ou fermer la clé de contact.

↳ The YELLOW LED is still ON.

↳ La DEL JAUNE reste allumée solide.

**KEY BYPASS PROGRAMMING PROCEDURE 4/4 | PROCÉDURE DE PROGRAMMATION CONTOURNEMENT DE CLÉ 4/4**

13

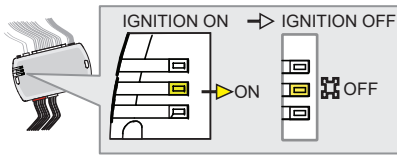
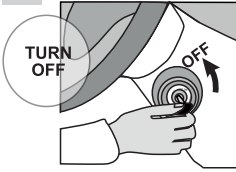

**Turn** the key to the OFF position.

**Tournez** la clé à la position Arrêt (OFF).

↳ The YELLOW will turn OFF.



The module is now programmed.  
Le module est programmé.



**REMOTE STARTER / ALARM VERIFICATION PROCEDURE | PROCÉDURE DE VÉRIFICATION DU DÉMARREUR À DISTANCE / ALARME**

**Test** the remote starter. **Remote start** the vehicle.  
**Testez** le démarreur à distance. **Démarrez** le véhicule à distance.



**REMOTE STARTER FUNCTIONALITY | FONCTIONNALITÉS DU DÉMARREUR À DISTANCE**



All doors must be closed.

Toutes les portes doivent être fermées.



Remote start the vehicle.

Démarrez à distance.



Unlock the doors with the remote-starter remote or the OEM remote.

Déverrouillez les portes avec la télécommande du démarreur à distance ou la télécommande d'origine.

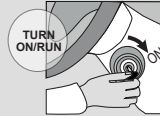

Insert and Turn the key to the Ignition ON/RUN position.

Insérez et tournez la clé à la position "ON/RUN".



Press the brake pedal.

Appuyez sur la pédale de frein.



The vehicle can now be put in to gear and driven.

Vous êtes maintenant prêt à embrayer et prendre la route.



Module label | Étiquette sur le module

### Notice: Updated Firmware and Installation Guides

Updated firmware and installation guides are posted on our web site on a regular basis. We recommend that you update this module to the latest firmware and download the latest installation guide(s) prior to the installation of this product.

### Notice: Mise à jour microprogramme et Guides d'installations

Des mises à jour du Firmware (microprogramme) et des guides d'installation sont mis en ligne régulièrement. Vérifiez que vous avez bien la dernière version logiciel et le dernier guide d'installation avant l'installation de ce produit.

## WARNING

The information on this sheet is provided on an (as is) basis with no representation or warranty of accuracy whatsoever. It is the sole responsibility of the installer to check and verify any circuit before connecting to it. Only a computer safe logic probe or digital multimeter should be used. FORTIN ELECTRONIC SYSTEMS assumes absolutely no liability or responsibility whatsoever pertaining to the accuracy or currency of the information supplied. The installation in every case is the sole responsibility of the installer performing the work and FORTIN ELECTRONIC SYSTEMS assumes no liability or responsibility whatsoever resulting from any type of installation, whether performed properly, improperly or any other way. Neither the manufacturer or distributor of this module is responsible of damages of any kind indirectly or directly caused by this module, except for the replacement of this module in case of manufacturing defects. This module must be installed by qualified technician. The information supplied is a guide only. This instruction guide may change without notice. Visit [www.fortinbypass.com](http://www.fortinbypass.com) to get the latest version.

## MISE EN GARDE

L'information de ce guide est fournie sur la base de représentation (telle quelle) sans aucune garantie de précision et d'exactitude. Il est de la seule responsabilité de l'installateur de vérifier tous les fils et circuits avant d'effectuer les connexions. Seuls une sonde logique ou un multimètre digital doivent être utilisés. FORTIN SYSTÈMES ÉLECTRONIQUES n'assume aucune responsabilité de l'exactitude de l'information fournie. L'installation (dans chaque cas) est la responsabilité de l'installateur effectuant le travail. FORTIN SYSTÈMES ÉLECTRONIQUES n'assume aucune responsabilité suite à l'installation, que celle-ci soit bonne, mauvaise ou de n'importe autre type. Ni le manufacturier, ni le distributeur ne se considèrent responsables des dommages causés ou ayant pu être causés, indirectement ou directement, par ce module, excepté le remplacement de ce module en cas de défectuosité de fabrication. Ce module doit être installé par un technicien qualifié. L'information fournie dans ce guide est une suggestion. Ce guide d'instruction peut faire l'objet de changement sans préavis. Consultez le [www.fortinbypass.com](http://www.fortinbypass.com) pour voir la plus récente version.

Copyright © 2006-2018, FORTIN AUTO RADIO INC ALL RIGHTS RESERVED PATENT PENDING



## TECH SUPPORT

Tél: 514-255-HELP (4357)  
1-877-336-7797



## ADDENDUM GUIDE

[www.fortinbypass.com](http://www.fortinbypass.com)

WEB UPDATE | MISE À JOUR INTERNET

