

SCION / TOYOTA / LEXUS

 ADDENDUM - SUGGESTED WIRING CONFIGURATION
 ADDENDUM - SCHÉMA DE BRANCHEMENT SUGGÉRÉ

VEHICLE VEHICULES	Automatic Transmission only Transmission automatique seulement	YEARS ANNÉES	Connection	Programming	Immobilizer bypass
LEXUS					
GS 300	Automatic Transmission	1998-2005	2	1	•
GS 350	Push-to-Start (AT)	2007-2008	1	1	•
GS 400	Automatic Transmission	1997-2000	2	1	•
GS 430	Automatic Transmission	2001-2005	2	1	•
	Push-to-Start (AT)	2006-2007	1	1	•
GS 450H	Push-to-Start (AT)	2007-2008	1	1	•
GS 460	Push-to-Start (AT)	2008	1	1	•
IS 250	Push-to-Start (AT)	2007-2008	1	1	•
IS 300	Automatic Transmission	2001-2005	2	1	•
LS 400	Automatic Transmission	1997-2000	2	1	•
LS 430	Automatic Transmission	2003-2006	1	1	•
LX 470	Automatic Transmission	1998-2002	2	1	•
	Automatic Transmission	2003-2005	1	1	•
	Automatic Transmission	2006	1	1	•
RX 300	Automatic Transmission	1999-2003	2	1	•
SC 300	Automatic Transmission	1998-2000	2	1	•
SC 400	Automatic Transmission	1998-2000	2	1	•
TOYOTA					
4 Runner	Automatic Transmission	1999-2002	2	1	•
	Automatic Transmission	2003-2009	1	1	•
Avalon	Automatic Transmission	1998-2004	2	1	•
Corolla	Automatic Transmission	2005-2008	1	1	•
Land Cruiser	Automatic Transmission	1998-2002	2	1	•
Matrix	Automatic Transmission	2005-2008	1	1	•
MR2 - Spyder	Automatic Transmission	2003-2005	2	1	•
Rav4	Automatic Transmission	2001-2003	2	1	•
	Automatic Transmission	2004-2005	1	1	•
Sequoia	Automatic Transmission	2008-2009	1	1	•
Sienna	Automatic Transmission	1999-2003	2	1	•
	Automatic Transmission	2004-2010	1	1	•
Solara	Automatic Transmission	1999-2003	2	1	•
Yaris	Automatic Transmission	2005-2009	1	1	•



This manual may change without notice.
www.fortinbypass.com for latest version.
 Ce Guide peut faire l'objet de changement sans préavis.
www.fortinbypass.com pour la récente version.



**Program remote
 starter option:
 Programmez l'option
 démarreur à distance:**

**FUNCTION
 FONCTION**
2

MODE
1

DESCRIPTION
 (+) Ignition 2 (E1) (By default)
 (+) Ignition 2 (E1) (Par défaut)

20

2

Tachless only. (vehicles with automatic transmission only)
 Sans Tachymètre seulement. (véhicules à transmission automatique
 seulement)

CONNECTION 1

GO PROGRAM: 1

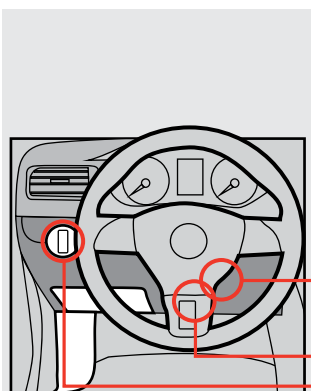
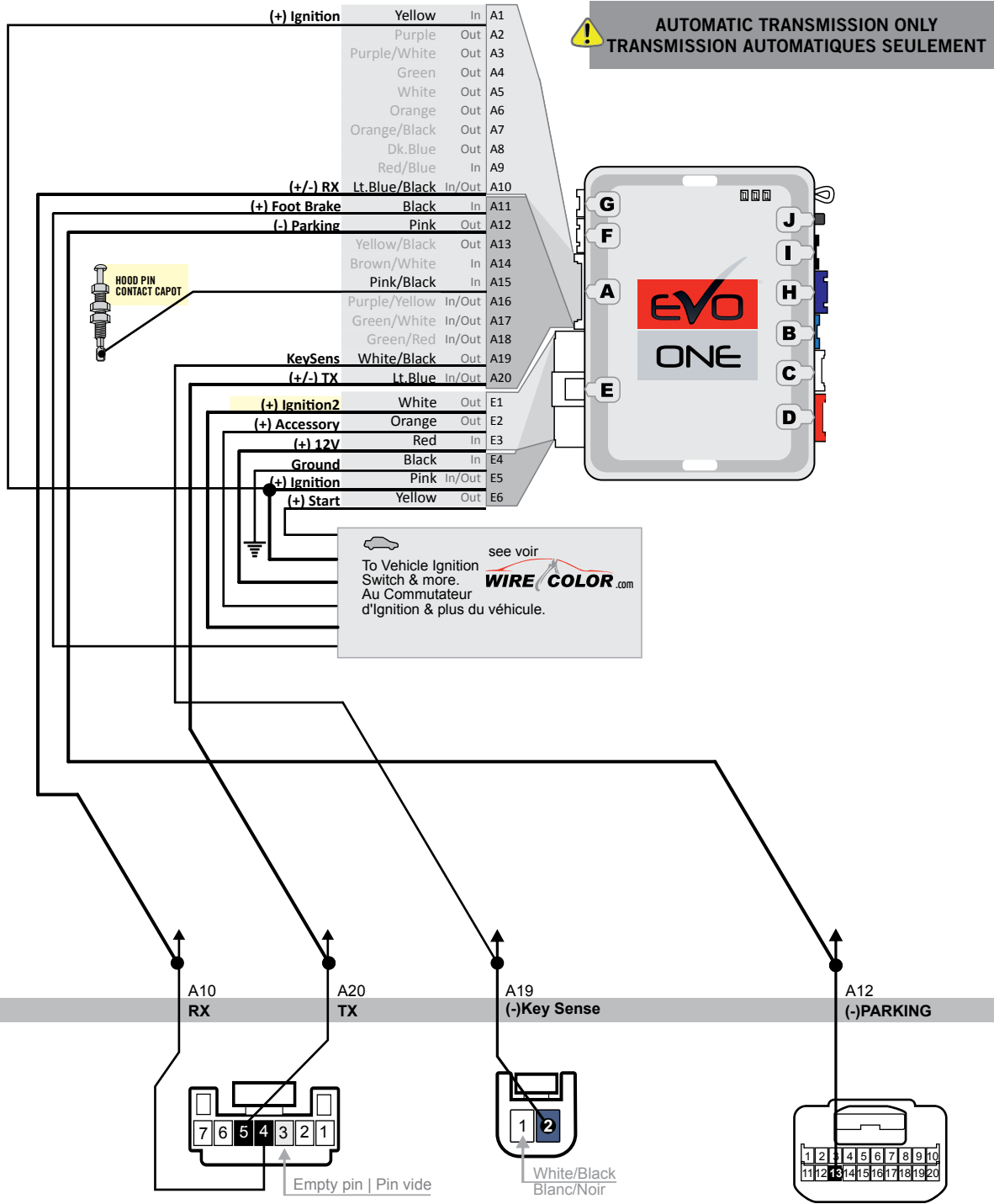

Back view - 7-Pin White Ignition Connector
Vue de dos - Connecteur Blanc 7-Pins au barillet d'ignition

Back view - 2-Pin White connector Steering column
Vue de dos - Connecteur 2-Pins Blanc Colonne de direction

Back view - White connector Light switch harness
Vue de dos - Connecteur Blanc Harnais feux de stationnement

CONNECTION 2

GO PROGRAM: 1

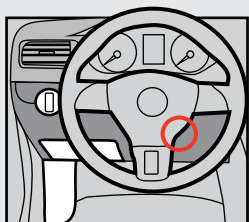
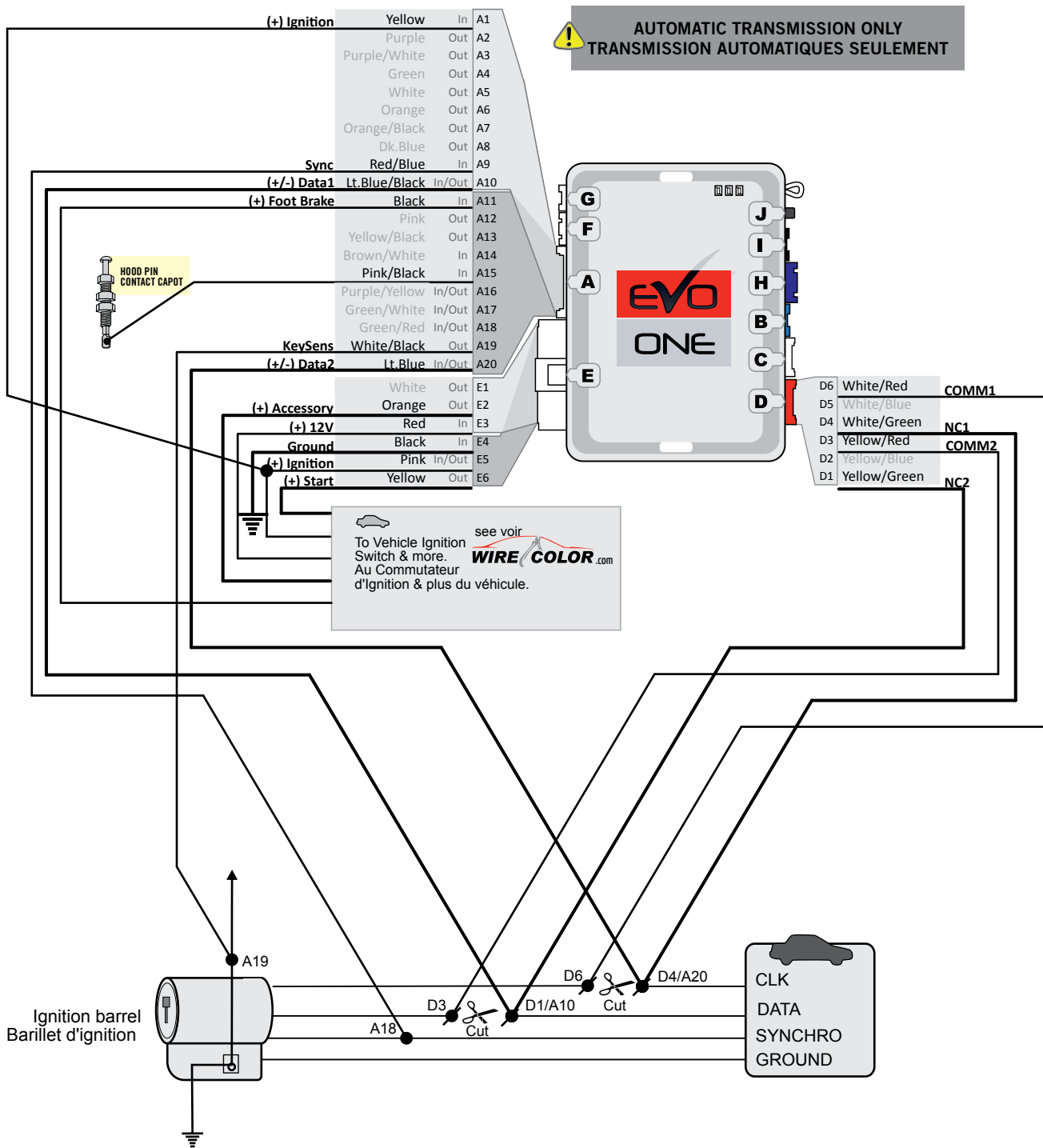

LEXUS	YEARS	CLK	DATA	Synchro	Key Sense	TOYOTA	YEARS	CLK	DATA	Synchro	Key Sense
ES 300	98-01	Red/Blue	Green/White	Blue/Yellow	Blue/Black	4Runner	99-02	Red/Black	Gray/Red	Pink/Black	Yellow/Red
	02-03	Red/Blue	Green/White	Blue/Yellow	Blue	Avalon	98-99	Yellow	Black/Red	Green	Red/Yellow
GS 300	98-05	Black/White	Green/Black	Blue/Red	Yellow		00-04	Blue/Orange	Pink/Green	Blue/Yellow	Red/White
GS 400	98-00	Black/White	Green/Black	Blue/Red	Yellow	Camry	96-00	Red/Blue	Green/White	Blue/Yellow	Blue/Black
GS 430	01-05	Black/White	Green/Black	Blue/Red	Yellow		01	Red/Blue	Green/White	Blue/Yellow	Blue/Black
IS300	01	Purple	Green	Pink	Black/Yellow		02-04*	Red/Blue	Green/White	Blue/Yellow	Blue
	02-05	Purple	Green/Black	Pink/Black	Black/Yellow		*Camry 2003 - 2004 - 4 Cylinder Engines Only				
LS 400	98-00	Red/Black	Red/White	Red	Yellow	Highlander	99-03	Pink	Gray/Blue	Gray	Blue
LX 470	98-02	Purple/Green	Blue/Black	Red/Yellow	Red/White	Land Cruiser	98-10	Purple/Green	Blue/Black	Red/Yellow	Red/Black
RX 300	99	Black	Purple	Gray	Blue	MR2 Spider	03-05	Yellow	Yellow/Green	Yellow/Black	Blue/Red
	00-03	Pink	Purple	Gray	Blue	RAV4	01-03	Yellow	Yellow/Green	Yellow/Black	Blue/Red
SC300	99-00	Blue	Black/Orange	Green/Orange	Yellow	Sienna	99-03	Brown/Red	Brown/White	Brown/Yellow	Blue/Black
SC400	99-00	Blue	Black/Orange	Green/Orange	Yellow	Solara	99-03	Red/Blue	Green/White	Blue/Yellow	Blue/Black

KEY BYPASS PROGRAMMING PROCEDURE | PROCÉDURE DE PROGRAMMATION CONTOURNEMENT DE CLÉ

1

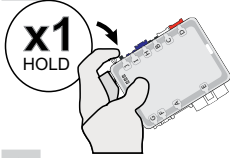

Press and hold the programming button.

Appuyez et maintenez enfoncé le bouton de programmation.

2

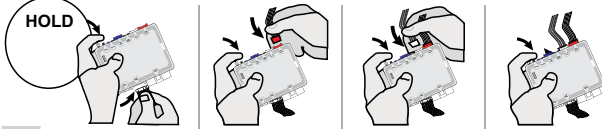

Insert the connectors:
20 pin (White),
6 pin (Red),
5 pin (White),
2 pin (White).
(If required)

Insérez les connecteurs:
20 pins (Blanc),
6 pins (Rouge),
5 pins (Blanc),
2 pins (Blanc).
(Si requis)

3

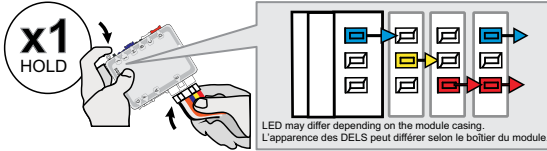

Insert the 6-Pin Main connector.

Insérez le connecteur Principal à 6-broches.

↳The LEDs will alternate between BLUE, RED, YELLOW & BLUE/RED flashes.

↳Les DELS alterneront entre un clignotement BLEU, ROUGE, JAUNE & BLEU/ROUGE.

4

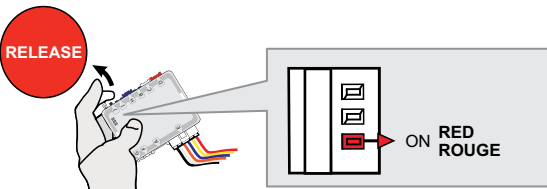

Release the programming button when the LED is RED.

Relâchez le bouton de programmation quand la DEL est ROUGE.

If the LED is not solid RED disconnect the 6 Pin connector (Main-Harness) and go back to step 1.

Si le DEL n'est pas ROUGE solide débranchez le connecteur 6 pins (Connecteur principal) et allez à l'étape 1.

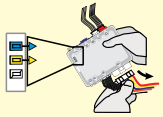

5

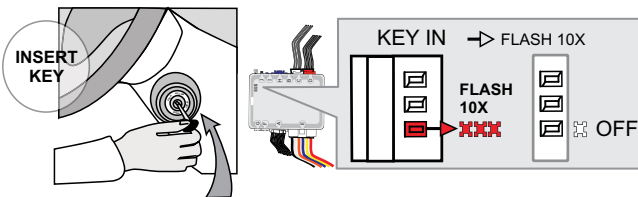

Insert one functional key into the ignition barrel.

Insérez la clé fonctionnelle dans le barillet.

DO NOT turn ON the key.

Ne tournez pas la clé.

↳The RED LED will flash rapidly 10x times.
Key bypass programmed.

↳La DEL ROUGE clignotera 10x fois rapidement.
Contournement de clé programmé.

If the LED is solid RED disconnect the 6 Pin connector (Main-Harness) and go back to step 1.

Si le DEL est ROUGE solide débranchez le connecteur 6 pins (Connecteur principal) et allez à l'étape 1.

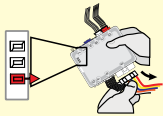

6

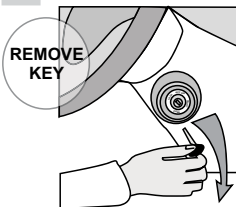

Remove the key from the ignition barrel.

Retirez la clé du barillet d'ignition.



The module is now programmed.

Le module est programmé.

Use the remote of the remote starter or security system to test all of the supported features to ensure proper programming.

Testez toutes les fonctions supportées sur le véhicule avec la télécommande du démarreur à distance ou du système de sécurité.

REMOTE STARTER PROGRAMMING PROCEDURE | PROCÉDURE DE PROGRAMMATION DU DÉMARREUR À DISTANCE

 REFER TO THE **QUICK INSTALL GUIDE** INCLUDED WITH THE MODULE FOR THE REMOTE STARTER PROGRAMMING.

 RÉFÉREZ-VOUS AU **GUIDE D'INSTALLATION RAPIDE** INCLUS AVEC LE MODULE POUR LA PROGRAMMATION DU DÉMARREUR À DISTANCE.

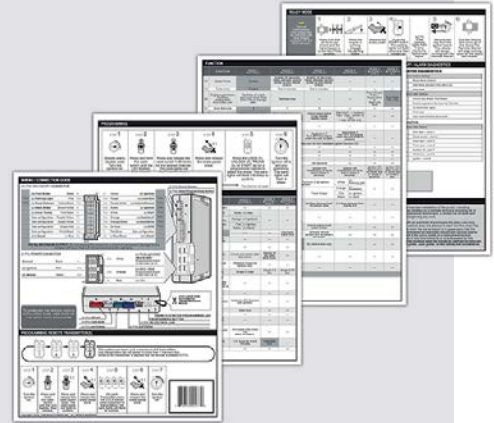



Module label | Étiquette sur le module

Notice: Updated Firmware and Installation Guides

Updated firmware and installation guides are posted on our web site on a regular basis. We recommend that you update this module to the latest firmware and download the latest installation guide(s) prior to the installation of this product.

Notice: Mise à jour microprogramme et Guides d'installations

Des mises à jour du Firmware (microprogramme) et des guides d'installation sont mis en ligne régulièrement. Vérifiez que vous avez bien la dernière version logiciel et le dernier guide d'installation avant l'installation de ce produit.

WARNING

The information on this sheet is provided on an (as is) basis with no representation or warranty of accuracy whatsoever. It is the sole responsibility of the installer to check and verify any circuit before connecting to it. Only a computer safe logic probe or digital multimeter should be used. FORTIN ELECTRONIC SYSTEMS assumes absolutely no liability or responsibility whatsoever pertaining to the accuracy or currency of the information supplied. The installation in every case is the sole responsibility of the installer performing the work and FORTIN ELECTRONIC SYSTEMS assumes no liability or responsibility whatsoever resulting from any type of installation, whether performed properly, improperly or any other way. Neither the manufacturer or distributor of this module is responsible of damages of any kind indirectly or directly caused by this module, except for the replacement of this module in case of manufacturing defects. This module must be installed by qualified technician. The information supplied is a guide only. This instruction guide may change without notice. Visit www.fortinbypass.com to get the latest version.

MISE EN GARDE

L'information de ce guide est fournie sur la base de représentation (telle quelle) sans aucune garantie de précision et d'exactitude. Il est de la seule responsabilité de l'installateur de vérifier tous les fils et circuits avant d'effectuer les connexions. Seuls une sonde logique ou un multimètre digital doivent être utilisés. FORTIN SYSTÈMES ÉLECTRONIQUES n'assume aucune responsabilité de l'exactitude de l'information fournie. L'installation (dans chaque cas) est la responsabilité de l'installateur effectuant le travail. FORTIN SYSTÈMES ÉLECTRONIQUES n'assume aucune responsabilité suite à l'installation, que celle-ci soit bonne, mauvaise ou de n'importe autre type. Ni le manufacturier, ni le distributeur ne se considèrent responsables des dommages causés ou ayant pu être causés, indirectement ou directement, par ce module, excepté le remplacement de ce module en cas de défectuosité de fabrication. Ce module doit être installé par un technicien qualifié. L'information fournie dans ce guide est une suggestion. Ce guide d'instruction peut faire l'objet de changement sans préavis. Consultez le www.fortinbypass.com pour voir la plus récente version.

Copyright © 2006-2014, FORTIN AUTO RADIO INC ALL RIGHTS RESERVED PATENT PENDING



TECH SUPPORT

Tél: 514-255-HELP (4357)
1-877-336-7797



ADDENDUM GUIDE

www.fortinbypass.com

WEB UPDATE | MISE À JOUR INTERNET

