

# Tacoma

## ADDENDUM - SUGGESTED WIRING CONFIGURATION SCHÉMA DE BRANCHEMENT SUGGÉRÉ



This guide is for vehicles having keys stamped with a **G** on the shaft.

Ce guide est pour les véhicules avec un **G** gravé sur la clé.

VEHICLE VEHICULES		YEARS ANNÉES	Lock	Unlock	Arm	Disarm	Trunk/Hatch	Tachometer	Start/Stop control	Door Status	Trunk Status	Hood Trigger	RAP Disable	Transponder Bypass	PK3, Passlock	Sliding door*	Defrost	Heated Seats	Gas Door	Window Roll Down	Hatch Trigger	Foot Brake Signal	Parking Light	Hand Brake Signal	Rear Defrost	Heated Mirrors	Memory Driver
			A	B	C	D	E	F	G	H	I	J	K	L	M	N	O	P	Q	R	S	T	U	V	W	X	Y
TOYOTA	Regular G Key	2010-2011																									
Tacoma	Regular G Key	2010-2011																									



Connection always **required**  
Branchement toujours **requis**

Connect to vehicle  
Branchement au véhicule

Connection **not required** with Data-link  
Branchement **non requis** avec Data-Link

Connect to Remote-Starter/Alarm  
Branchement au démarreur à distance/Alarme

### INSTALLATION WITH DATA-LINK INSTALLATION AVEC DATA-LINK

Remote Starter/Alarm with the **Fortin Data-link protocol**.  
Démarreur à distance/alarme avec le **protocole Data-link Fortin**

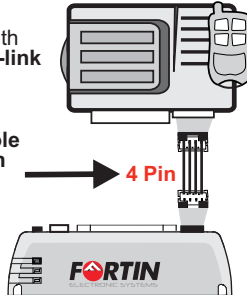

### INSTALLATION WITHOUT DATA-LINK INSTALLATION SANS DATA-LINK

Remote Starter/Alarm  
Démarreur à distance/alarme

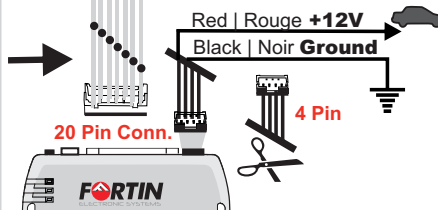





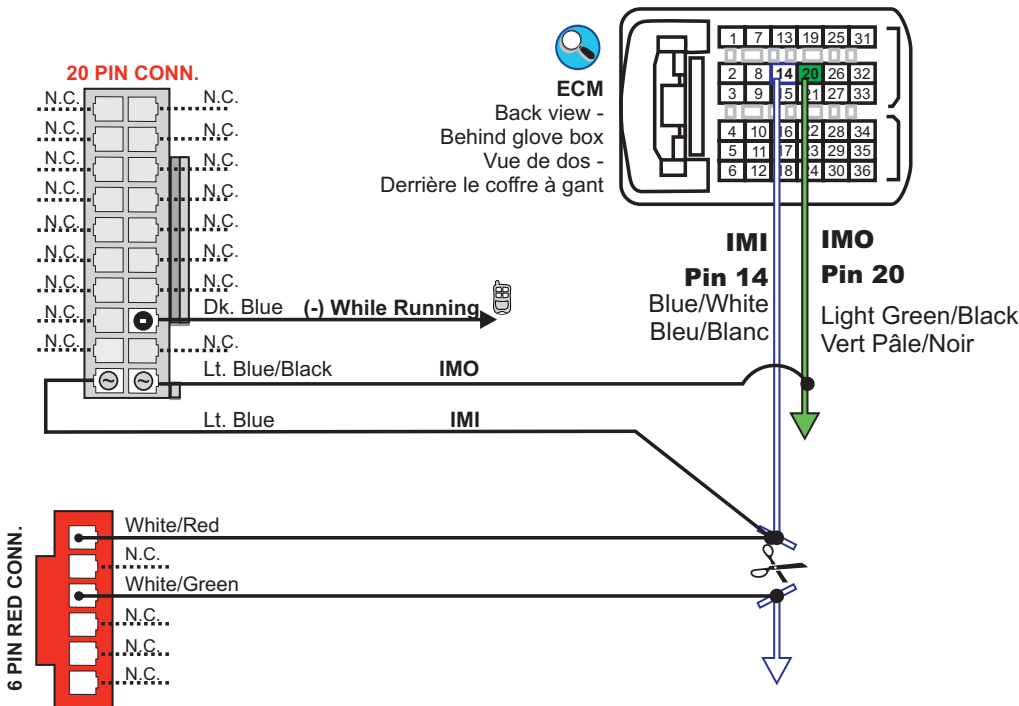

- 1 Cut off one plug of the 4 Pin Data-Link connector
- 2 Connect the Red wire to +12V
- 3 Connect the Black wire to Ground

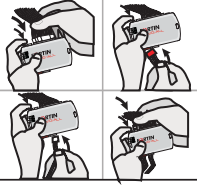
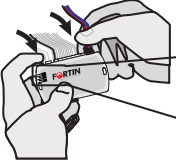
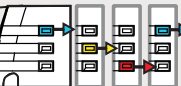
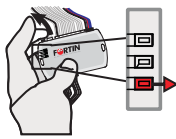
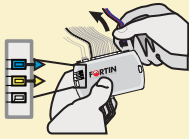
- 1 Coupez l'extrémité du connecteur 4 pins Data-Link
- 2 Connectez le fil rouge au 12V
- 3 Connectez le fil noir à la masse du véhicule.



**PROGRAMMING PROCEDURE | PROCÉDURE DE PROGRAMMATION**

<p><b>1</b></p>  <p><b>Press and hold</b> the programming button:</p> <p><b>Appuyez et maintenir enfoncé</b> le bouton de programmation:</p>	 <p><b>Insert</b> the required remaining connectors:</p> <p>20 pin (White), 5 pin (White), 6 pin (Red), 2 pin (White),</p> <p><b>Insérez</b> les connecteurs requis restants:</p> <p>20 pins (Blanc), 2 pins (Blanc), 5 pins (Blanc), 6 pins (Rouge)</p>	 <p><b>Insert</b> the 4 Pin (Data-Link) connector.</p> <p><b>Insérez</b> le connecteur 4 pins (Data-Link).</p>	 <p>The LED will alternate between <b>BLUE, YELLOW and RED</b> flashes.</p> <p>Les DELS alternent entre une flash <b>BLEU, JAUNE et ROUGE.</b></p>	 <p><b>Release</b> the programming button when the LED is <b>RED.</b></p> <p><b>Relâchez</b> le bouton de programmation quand la DEL est <b>ROUGE.</b></p>	 <p>If the LED is not solid RED disconnect the 4 Pin connector (Data-Link) and go back to beginning of step 3. Si le DEL n'est pas ROUGE solide débranchez le connecteur 4 pins (Data-Link) et allez au début de l'étape 3.</p>
<p><b>2</b></p>  <p><b>Turn</b> the Ignition to the ON/RUN position.</p> <p><b>Tournez</b> la clef en position <b>ignition (ON).</b></p>	 <p><b>Start</b> the vehicle.</p> <p><b>Démarrez</b> le véhicule.</p>	 <p>Wait a few seconds</p> <p>Attendre quelques secondes</p>	 <p>Flash <b>xxx x10</b></p> <p>The RED LED will flash rapidly ten (10) times. Key Bypass programmed.</p> <p>La DEL ROUGE clignotera dix (10) fois rapidement. Contournement de clé programmé.</p>	 <p>OFF</p> <p>The RED LED will turn off.</p> <p>Le DEL ROUGE s'éteint.</p>	 <p>The module is now programmed.</p> <p>Le module est programmé.</p>

# EVO-ALL



Module label | Étiquette sur le module

## **Notice:** Updated Firmware and Installation Guides

**Updated firmware and installation guides** are posted on our web site on a regular basis. We recommend that you update this module to the latest firmware and download the latest installation guide(s) prior to the installation of this product.

**Des mises à jour du Firmware (microprogramme) et des guides d'installation** sont mises en ligne régulièrement. Vérifiez que vous avez bien la dernière version logiciel et le dernier guide d'installation avant l'installation de ce produit.

## **WARNING / TECH SUPPORT / MISE EN GARDE / SUPPORT TECHNIQUE**

The information on this sheet is provided on an (as is) basis with no representation or warranty of accuracy whatsoever. It is the sole responsibility of the installer to check and verify any circuit before connecting to it. Only a computer safe logic probe or digital multimeter should be used. FORTIN ELECTRONIC SYSTEMS assumes absolutely no liability or responsibility whatsoever pertaining to the accuracy or currency of the information supplied. The installation in every case is the sole responsibility of the installer performing the work and FORTIN ELECTRONIC SYSTEMS assumes no liability or responsibility whatsoever resulting from any type of installation, whether performed properly, improperly or any other way. Neither the manufacturer or distributor of this module is responsible of damages of any kind indirectly or directly caused by this module, except for the replacement of this module in case of manufacturing defects. This module must be installed by qualified technician. The information supplied is a guide only. This instruction guide may change without notice. **Visit [www.fortinbypass.com](http://www.fortinbypass.com) to get the latest version.**

L'information de ce guide est fournie sur la base de représentation (telle quelle) sans aucune garantie de précision et d'exactitude. Il est de la seule responsabilité de l'installateur de vérifier tous les fils et circuit avant défectuer les connections. Seule une sonde logique ou un multimètre digital doivent être utilisés. FORTIN SYSTÈMES ÉLECTRONIQUES n'assume aucune responsabilité de l'exactitude de l'information fournie. L'installation (dans chaque cas) est la responsabilité de l'installateur effectuant le travail. FORTIN SYSTÈMES ÉLECTRONIQUES n'assume aucune responsabilité suite à l'installation, que celle-ci soit bonne ou mauvaise ou de n'importe autre type. Ni le fabricant, ni le distributeur ne se considèrent responsables des dommages causés ou ayant pu être causés, indirectement ou directement, par ce module, excepté le remplacement de ce module en cas de défectuosité de fabrication. Ce module doit être installé par un technicien qualifié. L'information fournie dans ce guide est une suggestion. Ce guide d'instruction peut faire l'objet de changement sans préavis. **Consultez le [www.fortinbypass.com](http://www.fortinbypass.com) pour voir la plus récente version.**

Copyright © 2006-2011, FORTIN AUTO RADIO INC ALL RIGHTS RESERVED **PATENT PENDING**



**TECH SUPPORT**  
Tél: 514-255-HELP (4357)  
1-877-336-7797



**ADDENDUM GUIDE**

**[www.fortinbypass.com](http://www.fortinbypass.com)**  
WEB UPDATE | MISE À JOUR INTERNET

