



# Chevrolet Epica (TL) 2004-2007



## KEY-OVERRIDE-ALL

Made in Canada Rev. A - 02 / 07 / 2008  
Web site: <http://www.ifar.ca>

ENCRYPTED TRANSPONDER BYPASS MODULE ( Self Learning )

**LED Module Diagnostics :**  
On: Activated.  
Off: Not activated.  
Flash: Not programmed.

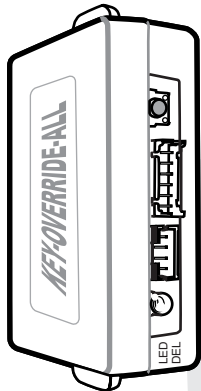

Front view of the module

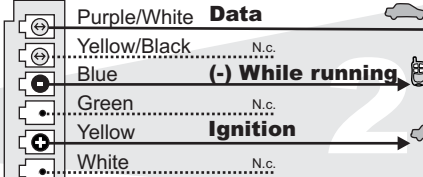

BCM  
Located right side of steering column.  
(Integrated fuse box)

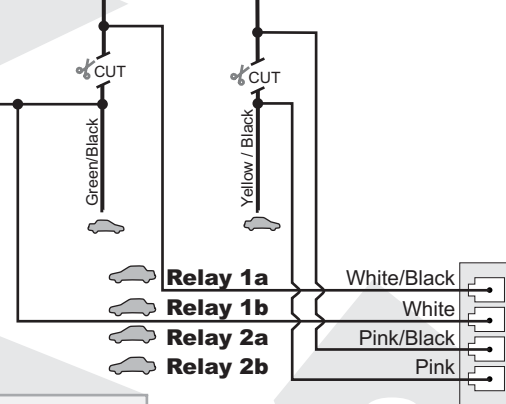
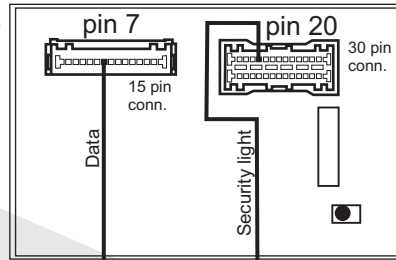

**Connector 1 (Black - 4 pins):**  
Determine the type of installation:

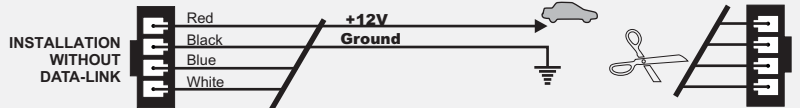
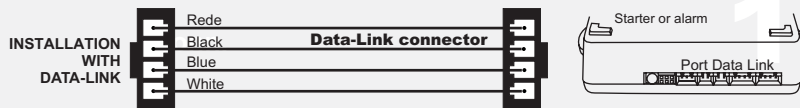

Cut off one plug of the Data-Link connector, connect the red wire to +12V and the black wire to ground.

**Connector 4 (White - 4 pins):**  
Connect with the **FLASH LINK UPDATER** for web update.



Back view of the module

Connect wire to Remote-Starter/Alarm Connect wire to vehicle

○ OUTPUT ● INPUT

**1** **Make the connections to the vehicle:**

**1.A** **Connector 1 (Black):**  
Determine the type of installation:  
- **INSTALLATION WITH DATA-LINK**  
- **INSTALLATION WITHOUT DATA-LINK**

**1.B** **Connector 2 (White):** Make the connections  
**Connector 3 (White):** Make the connections

**2** Press and hold the programming button.  
Insert **connector 1**.

**3** Insert **connector 2**.  
If the LED is flashing at this point the module is already programmed and can't be programmed again. (To prevent malicious use this module can be programmed in only one vehicle.)

**4** While holding the programming button.  
Insert **connector 3**.

**5** Release the programming button  
when the LED turns ON.

**6** Press **1 time** on the programming button.  
The LED turns OFF and turns ON.

**7** Press **2 more times** on the programming  
button and the LED will flash twice.

**8** Turn the **Ignition to the ON** position.

**9** **If the LED flashes 10 times, the module is programmed.**  
If the LED stays ON, verify your connections and repeat from step 1.

**10** Turn the Ignition key to the **OFF** position.

**11** Remove the key and start the vehicle using the remote starter to ensure functionality.



**Technical support:**  
TEL: 514-255-HELP (4357)  
FAX: 514-255-1367  
Web: [www.ifar.ca](http://www.ifar.ca)

Neither the manufacturer or distributor of this module is responsible of damages of any kind indirectly or directly caused by this module, except for the replacement of this module in case of manufacturing defects. This module must be install by qualified technician. This instruction guide may change without notice. Visit [www.ifar.ca](http://www.ifar.ca) to get latest version.



# Chevrolet Epica (TL) 2004-2007

MISE À JOUR PAR INTERNET

## KEY-OVERRIDE-ALL

Fabriqu  au Canada Rev. A - 02 / 07 / 2008  
Site internet <http://www.ifar.ca>

MODULE DE CONTOURNEMENT DE TRANSPONDER ENCRYPT  (Auto-apprentissage)

**Diagnostic du DEL du module**  
Allum : Le module est activ .  
 teint: Le module n'est pas activ .  
Flash: Le module n'est pas programm .

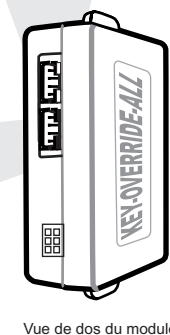
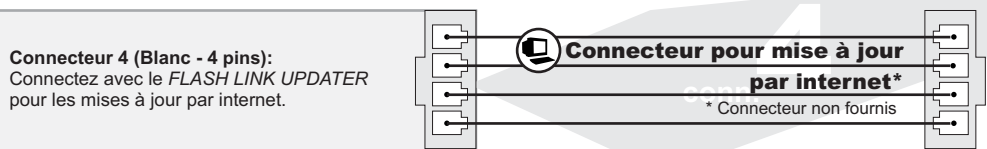
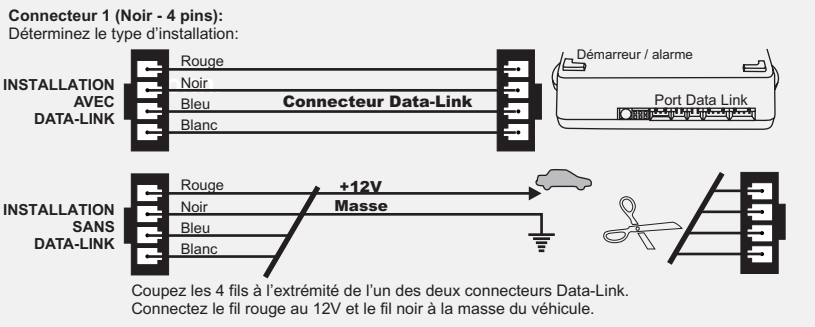
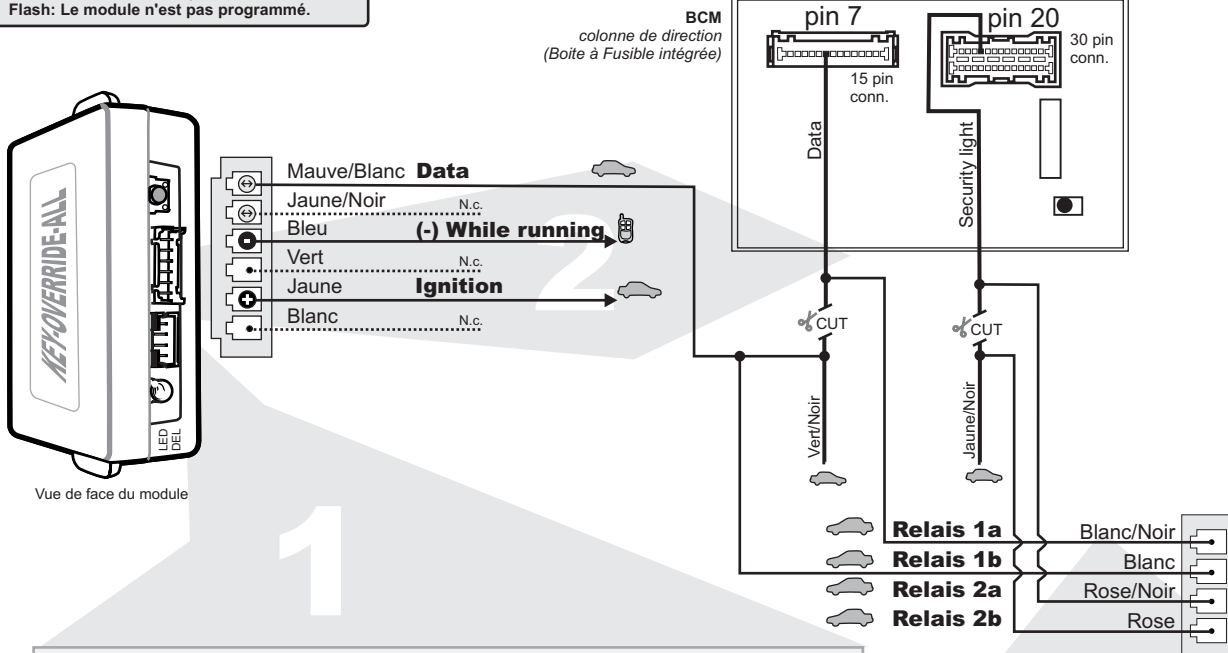

Vue de dos du module

Branchement du filage au d marreur   distance/Alarme Branchement du filage au v hicule ○ SORTIE ● ENTR E

- Effectuez les connexions au v hicule:**
  - Connecteur 1 (Noir):**  
D terminez le type d'installation:  
- Pour l'**INSTALLATION DATA-LINK**  
- Pour l'**INSTALLATION NON DATA-LINK**
  - Connecteur 2 (Blanc):** Effectuez les branchements.
- Maintenez le bouton de programmation enfonc . Ins rez le **connecteur 1**.
- Ins rez le **connecteur 2**.  
Si la DEL clignote alors le module a d j  t  programm  sur un v hicule et ne peut  tre programm    nouveau. (Dans le but de pr venir toute utilisation malicieuse, ce module peut  tre programm  dans seulement (1) un v hicule.)
- Gardez le bouton de programmation enfonc  et ins rez le **connecteur 3**.
- Lorsque la DEL s'allume, rel chez le bouton de programmation.
- Appuyez **1 fois** sur le bouton de programmation. La DEL s' teint et se rallume.
- Appuyez **2 autres fois** sur le bouton de programmation et la DEL clignotera deux coups.
- Tournez la clef en position **ignition (ON)**.
- La DEL clignote 10 fois le MODULE est programm .**  
Si la DEL reste allum e, v rifiez vos connexions et recommencez la programmation   partir de l' tape 1.
- Tournez la clef   **OFF**.
- Retirez la cl  du barillet et d marrez le v hicule avec le d marreur   distance.



**Support Technique:**  
TEL: 514-255-HELP (4357)  
FAX: 514-255-1367  
Site internet: [www.ifar.ca](http://www.ifar.ca)

Ni le manufacturier, ni le distributeur ne se consid rent responsables des dommages caus s ou ayant pu  tre caus s, indirectement ou directement, par ce module, except  le remplacement de ce module en cas de d fectuosit  de fabrication. Ce module doit  tre install  par un technicien qualifi . Ce guide d'instruction peut faire l'objet de changement sans pr avis. Consultez le [www.ifar.ca](http://www.ifar.ca) pour voir la plus r cente version.