



# TOYOTA Tacoma

## 2005-2009



# KEY-OVERRIDE-ALL

Made in Canada Rev. A - 02 / 07 / 2008  
Web site: <http://www.ifar.ca>

**LED Module Diagnostics :**  
On: Activated.  
OFF: Not activated.  
Flash: Not programmed.

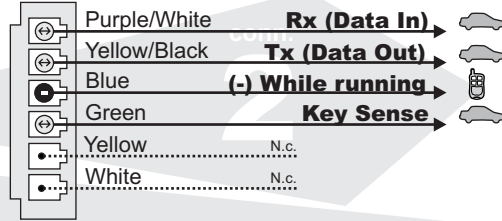
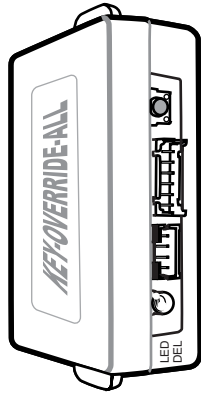

Key Sense **LOCATED NEXT** to the white/black wire

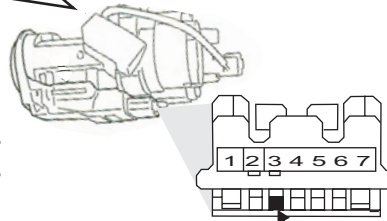

PIN #	DESCRIPTION
4	RX (Data)
5	TX (Data)

SEE [www.ifar.ca](http://www.ifar.ca) (KEY-OVERRIDE-SL2 INSTALLATION SUPPLEMENT) FOR VEHICLE WIRE COLORS

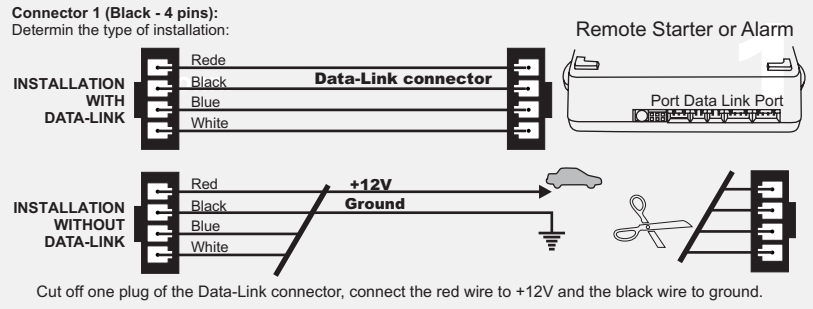

1

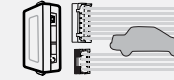

**Make the connections to the vehicle:**

1.A



**Connector 1 (Black):**  
Determine the type of installation:  
- INSTALLATION WITH DATA-LINK  
- INSTALLATION WITHOUT DATA-LINK

1.B



**Connector 2 (White):** Make the connections

2

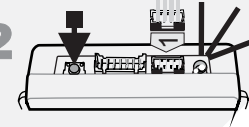

Keep programming button pressed while inserting **connector 1**.

3

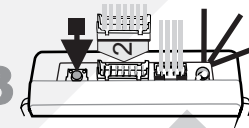

Insert **connector 2**.  
Release the programming button when the LED turns ON.

If the LED is flashing at this point the module is already programmed and can't be programmed again. (To prevent malicious use this module can be programmed in only one vehicle.)

4



Insert one functional key into the ignition barrel.  
**(do not turn the key).**

5

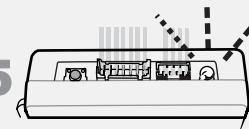

**If the LED flashes 10 times, the module is programmed.**

If the LED stays ON, verify your connections and repeat from step 1.

**Connector 4 (White - 4 pins):**  
Connect with the **FLASH LINK UPDATER** for web update.

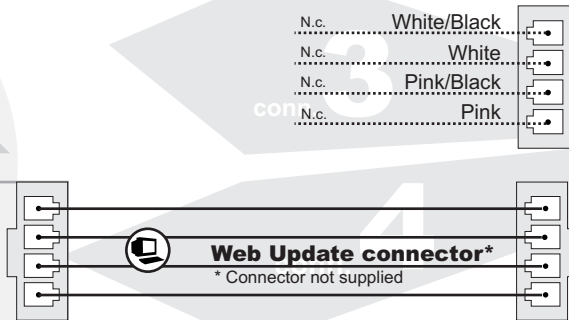

Back view of the module

🔌 Connect wire to Remote-Starter/Alarm 🚗 Connect wire to vehicle

○ OUTPUT ● INPUT



**Technical support:**  
TEL: 514-255-HELP (4357)  
FAX: 514-255-1367  
Web: [www.ifar.ca](http://www.ifar.ca)

Neither the manufacturer or distributor of this module is responsible of damages of any kind indirectly or directly caused by this module, except for the replacement of this module in case of manufacturing defects. This module must be install by qualified technician. This instruction guide may change without notice. Visit [www.ifar.ca](http://www.ifar.ca) to get latest version.



# TOYOTA Tocama

## 2005-2009



# KEY-OVERRIDE-ALL

Fabriqu  au Canada Rev. A - 02 / 07 / 2008  
Site internet <http://www.ifar.ca>

MODULE DE CONTOURNEMENT DE TRANSPONDER ENCRYPT  (Auto-apprentissage)

Diagnostic du DEL du module  
Allum : Le module est activ .  
 teint: Le module n'est pas activ .  
Flash: Le module n'est pas programm .

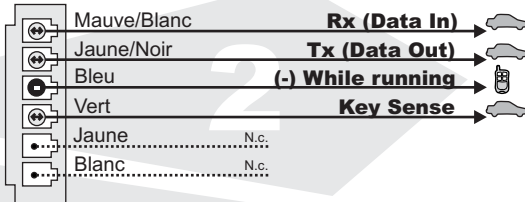
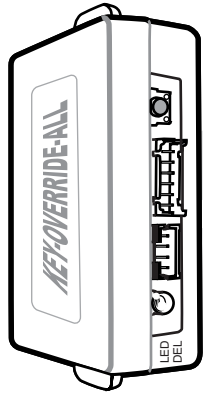

Fil Key Sense TOUJOURS SITU   
  C T  du fil BLANC/NOIR

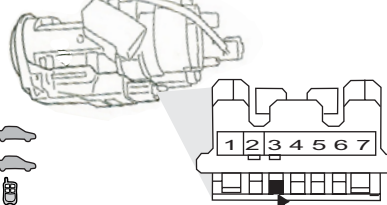

PIN #	DESCRIPTION
4	RX (Data)
5	TX (Data)

VOIR [www.ifar.ca](http://www.ifar.ca) (KEY-OVERRIDE-SL2 SUPPL MENT  
D'INSTALLATION) POUR LES COULEURS DE FILS DES  
CONNECTEURS.

Connecteur 1 (Noir - 4 pins):  
D terminez le type d'installation:

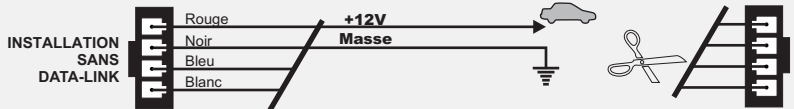
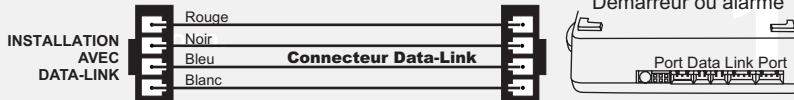

Coupez les 4 fils   l'extr mit  de l'un des deux connecteurs Data-Link.  
Connectez le fil rouge au 12V et le fil noir   la masse du v hicule.

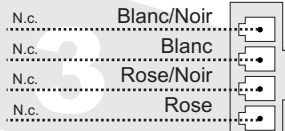

Connecteur 4 (Blanc - 4 pins):  
Connectez avec le FLASH LINK UPDATER  
pour les mises   jour par internet.

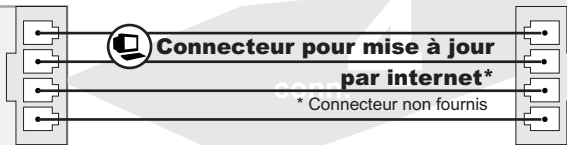

Vue de dos du module

Branchement du filage au d marreur   distance/Alarme Branchement du filage au v hicule ○ SORTIE ● ENTR E

1 Effectuez les connexions au v hicule:

1.A Connecteur 1 (Noir):  
D terminez le type d'installation:  
- INSTALLATION DATA-LINK  
- INSTALLATION NON DATA-LINK

1.B Connecteur 2 (Blanc):  
Effectuez les branchements.

2 Maintenez le bouton de programmation enfonc .  
Ins rez le connecteur 1 dans le module.

3 Ins rez le connecteur 2 dans le module.  
Lorsque la DEL s'allume, rel chez le bouton de programmation.

Si la DEL clignote alors le module a d j   t  programm  sur un v hicule et ne peut  tre programm    nouveau. (Dans le but de pr venir toute utilisation malicieuse, ce module peut  tre programm  dans seulement (1) un v hicule.)

4 Ins rez la cl  fonctionnelle dans le barillet.  
(Ne tournez pas la cl ).

5 La DEL clignote 10 fois le MODULE est programm .

Si la DEL reste allum e, v rifiez vos connexions et recommencez la programmation   partir de l' tape 1.



Support Technique:  
TEL: 514-255-HELP (4357)  
FAX: 514-255-1367  
Site internet: [www.ifar.ca](http://www.ifar.ca)

Ni le manufacturier, ni le distributeur ne se consid rent responsables des dommages caus s ou ayant pu  tre caus s, indirectement ou directement, par ce module, except  le remplacement de ce module en cas de d fectuosit  de fabrication. Ce module doit  tre install  par un technicien qualifi . Ce guide d'installation peut faire l'objet de changement sans pr avis. Consultez le [www.ifar.ca](http://www.ifar.ca) pour voir la plus r cente version.