

Sienna

ADDENDUM - SUGGESTED WIRING CONFIGURATION SCHÉMA DE BRANCHEMENT SUGGÉRÉ



This guide is for vehicles having keys stamped with a **G** on the shaft.

Ce guide est pour les véhicules avec un **G** gravé sur la clé.

VEHICLE VEHICULES		YEARS ANNÉES	Lock	Unlock	Arm	Disarm	Trunk/Hatch	Tachometer	Start/Stop control	Door Status	Trunk Status	Hood Trigger	RAP Disable	Transponder Bypass	PK3, Passlock	Sliding door*	Defrost	Heated seats	Gas Door	Window Roll Down	Hatch Trigger	Foot Brake Signal	Parking Light	Hand Brake Signal	Rear Defrost	Heated Mirrors	Memory Driver
			A	B	C	D	E	F	G	H	I	J	K	L	M	N	O	P	Q	R	S	T	U	V	W	X	Y
TOYOTA	Sienna	Regular Key	2011																								

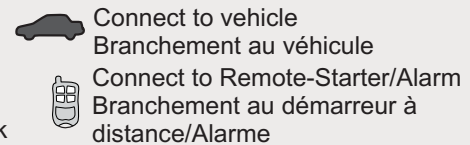
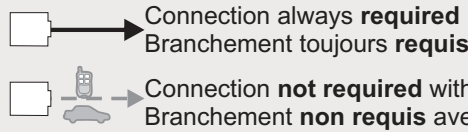

INSTALLATION WITH DATA-LINK INSTALLATION AVEC DATA-LINK

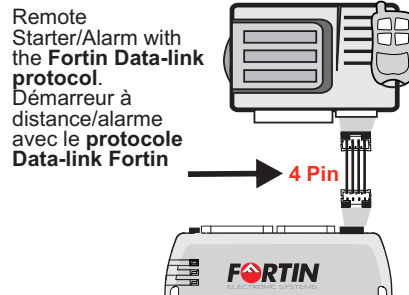

INSTALLATION WITHOUT DATA-LINK INSTALLATION SANS DATA-LINK

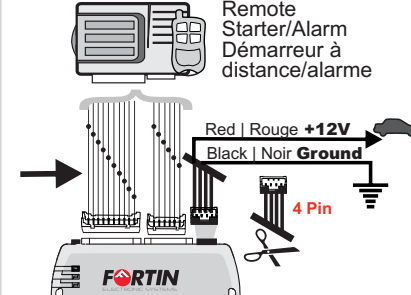

- 1 Cut off one plug of the 4 Pin Data-Link connector
- 2 Connect the Red wire to +12V
- 3 Connect the Black wire to Ground

- 1 Coupez l'extrémité du connecteur 4 pins Data-Link
- 2 Connectez le fil rouge au 12V
- 3 Connectez le fil noir à la masse du véhicule.

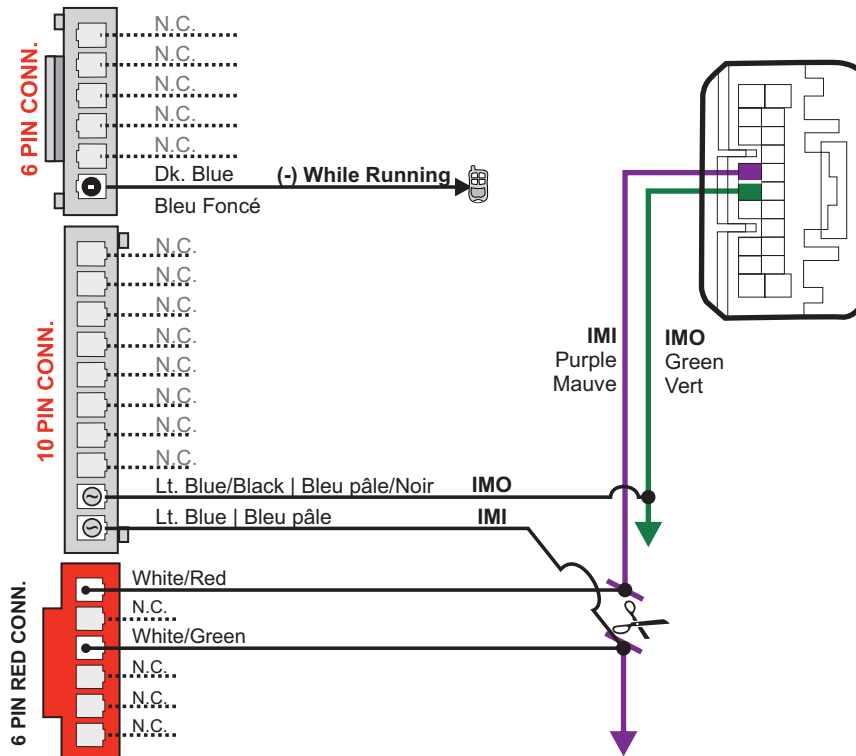

Back view - Left of the steering column
Vue de dos - Gauche de la colonne de direction

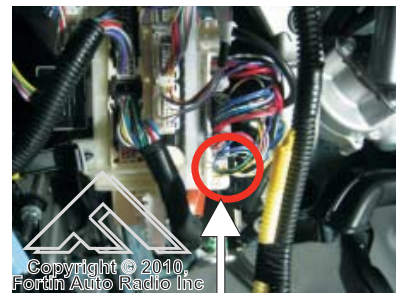

Copyright © 2010, Fortin Auto Radio Inc

Copyright © 2010, Fortin Auto Radio Inc

PROGRAMMING PROCEDURE | PROCÉDURE DE PROGRAMMATION

1



Press and hold the programming button:

Pressez le bouton de programmation:



Insert the connectors in the following order:

Insérez les connecteurs dans l'ordre suivant:

2

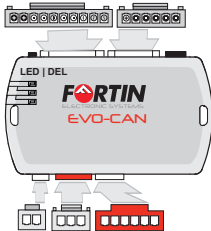

Insert the remaining connectors:

- 20 pin connector (White)
- 6 pin connector (Red)
- 5 pin connector (White)
- 2 pin connector (White)
- * If required.

Insérez les connecteurs restants:

- connecteur 20 pins (Blanc).
- connecteur 6 pins (Rouge).
- connecteur 5 pins (Blanc)
- connecteur 2 pins (Blanc).
- * Si requis.

3



Insert the 4 Pin (Data-Link) connector into the EVO-CAN module.

Insérez le connecteur 4 pins (Data-Link) dans le EVO-CAN.

4

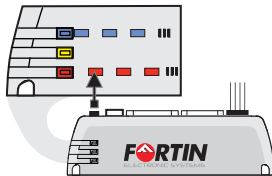

The LED will alternate between BLUE and RED flashes.

Les DELS alternent entre un flash BLEU et ROUGE,

Release the programming button when the LED is RED.

relâchez le bouton de programmation quand la DEL est ROUGE.

If the LED is not solid RED disconnect the 4 Pin connector (Data-Link) and go back to step 3

Si le DEL n'est pas ROUGE débranchez le connecteur 4 pins (Data-Link) et allez à l'étape 3

5

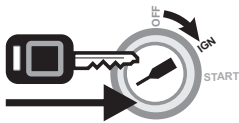

Turn the key to the ignition position.

Tournez la clef en position ignition.

6

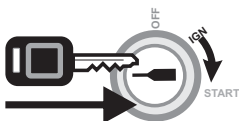

Start the vehicle with the key.

Démarrez le véhicule avec la clef.

7

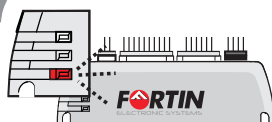

After few seconds the Red LED will flash rapidly.

Après quelques secondes la DEL Rouge clignote rapidement.

The module is programmed.

Le module est programmé.

EVO-CAN

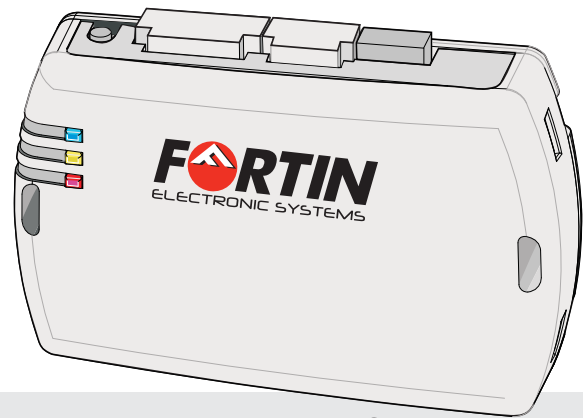

Module label | Étiquette sur le module

Notice: Updated Firmware and Installation Guides

Updated firmware and installation guides are posted on our web site on a regular basis. We recommend that you update this module to the latest firmware and download the latest installation guide(s) prior to the installation of this product.

Des mises à jour du Firmware (microprogramme) et des guides d'installation sont mises en ligne régulièrement. Vérifiez que vous avez bien la dernière version logiciel et le dernier guide d'installation avant l'installation de ce produit.

WARNING / TECH SUPPORT / MISE EN GARDE / SUPPORT TECHNIQUE

The information on this sheet is provided on an (as is) basis with no representation or warranty of accuracy whatsoever. It is the sole responsibility of the installer to check and verify any circuit before connecting to it. Only a computer safe logic probe or digital multimeter should be used. FORTIN ELECTRONIC SYSTEMS assumes absolutely no liability or responsibility whatsoever pertaining to the accuracy or currency of the information supplied. The installation in every case is the sole responsibility of the installer performing the work and FORTIN ELECTRONIC SYSTEMS assumes no liability or responsibility whatsoever resulting from any type of installation, whether performed properly, improperly or any other way. Neither the manufacturer or distributor of this module is responsible of damages of any kind indirectly or directly caused by this module, except for the replacement of this module in case of manufacturing defects. This module must be installed by qualified technician. The information supplied is a guide only. This instruction guide may change without notice. **Visit www.fortinbypass.com to get the latest version.**

L'information de ce guide est fournie sur la base de représentation (telle quelle) sans aucune garantie de précision et d'exactitude. Il est de la seule responsabilité de l'installateur de vérifier tous les fils et circuit avant défectuer les connections. Seule une sonde logique ou un multimètre digital doivent être utilisés. FORTIN SYSTÈMES ÉLECTRONIQUES n'assume aucune responsabilité de l'exactitude de l'information fournie. L'installation (dans chaque cas) est la responsabilité de l'installateur effectuant le travail. FORTIN SYSTÈMES ÉLECTRONIQUES n'assume aucune responsabilité suite à l'installation, que celle-ci soit bonne ou mauvaise ou de n'importe autre type. Ni le fabricant, ni le distributeur ne se considèrent responsables des dommages causés ou ayant pu être causés, indirectement ou directement, par ce module, excepté le remplacement de ce module en cas de défectuosité de fabrication. Ce module doit être installé par un technicien qualifié. L'information fournie dans ce guide est une suggestion. Ce guide d'instruction peut faire l'objet de changement sans préavis. **Consultez le www.fortinbypass.com pour voir la plus récente version.**

Copyright © 2006-2010, FORTIN AUTO RADIO INC ALL RIGHTS RESERVED **PATENT PENDING**



TECH SUPPORT

Tél: 514-255-HELP (4357)
1-877-336-7797



ADDENDUM GUIDE

www.fortinbypass.com

WEB UPDATE | MISE À JOUR INTERNET

