

Rav4 Built after may 2010
Construit après mai 2010

ADDENDUM - SUGGESTED WIRING CONFIGURATION
SCHEMA DE BRANCHEMENT SUGGERÉ



Parts required
1x 5A Fuse

Pièces requises
1x Fusible 5A

VEHICLE VEHICULES	YEARS ANNÉES	Functional if equipped / Fonctionnelle si le véhicule en est équipé.																									
		Lock	Unlock	Arm	Disarm	Trunk/Hatch	Tachometer	Start/Stop control	Door Status	Trunk Status	Hood Trigger	RAP Disable	Transponder Bypass	PK3, Passlock	Sliding door*	Defrost	Heated Seats	Gas Door	Window Roll Down	Hatch Trigger	Foot Brake Signal	Parking Light	Hand Brake Signal	Rear Defrost	Heated Mirrors	Memory Driver	
TOYOTA		A	B	C	D	E	F	G	H	I	J	K	L	M	N	O	P	Q	R	S	T	U	V	W	X	Y	
Rav4	Push to start	2009-2010																									

WIRE COLORS | COULEURS DE FIL

	POLARITY POLARITÉ	DESCRIPTION	COLOR COULEUR	LOCATION EMBLACEMENT
①	~	IMO	Light Green	Left of the steering column behind BCM
①	⚡	IMI	Pink	Left of the steering column behind BCM
②	+	Starter	White	Left of the steering column behind BCM
③	+	Ignition 1	Pink or Purple	Left of the steering column behind BCM
③	+	Ignition 2	White	Left of the steering column behind BCM
④	+	Accessory	Red	Left of the steering column behind BCM
⑤	+	12 Volts 1	Blue	Fuse Panel
⑥		Tach	Grey	Diagnostic Connector (OBD II)
⑦	+	Foot Brake	Blue	At Brake Switch
⑧	-	Lock & Arm	Blue	Driver Kick Panel White Connector
⑧	-	Unlock & Disarm	Pink	Driver Kick Panel White Connector Double Pulse.
⑨	-	Parking Lights	White	Light Switch Harness

RAV4 CONTINUED | SUITE

- Input
Entrée
- Output
Sortie

- Connection always **required**
Branchement toujours **requis**
- Connection **not required** with Data-link
Branchement **non requis** avec Data-Link

- Connect to vehicle
Branchement au véhicule
- Connect to Remote-Starter/Alarm
Branchement au démarreur à distance/Alarme

**INSTALLATION WITH DATA-LINK
INSTALLATION AVEC DATA-LINK**

Remote Starter/Alarm with the **Fortin Data-link protocol**.
Démarreur à distance/alarme avec le **protocole Data-link Fortin**

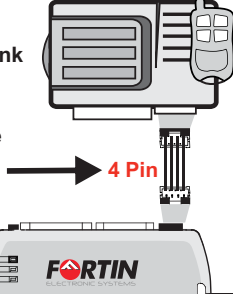

**INSTALLATION WITHOUT DATA-LINK
INSTALLATION SANS DATA-LINK**

Remote Starter/Alarm
Démarreur à distance/alarme

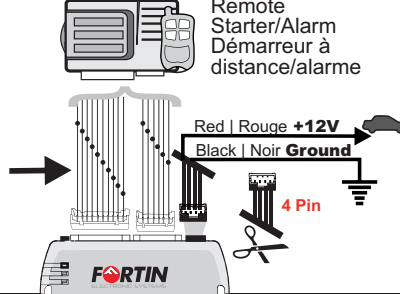

- 1 Cut off one plug of the 4 Pin Data-Link connector
- 2 Connect the Red wire to +12V
- 3 Connect the Black wire to Ground

- 1 Coupez l'extrémité du connecteur 4 pins Data-Link
- 2 Connectez le fil rouge au 12V
- 3 Connectez le fil noir à la masse du véhicule.

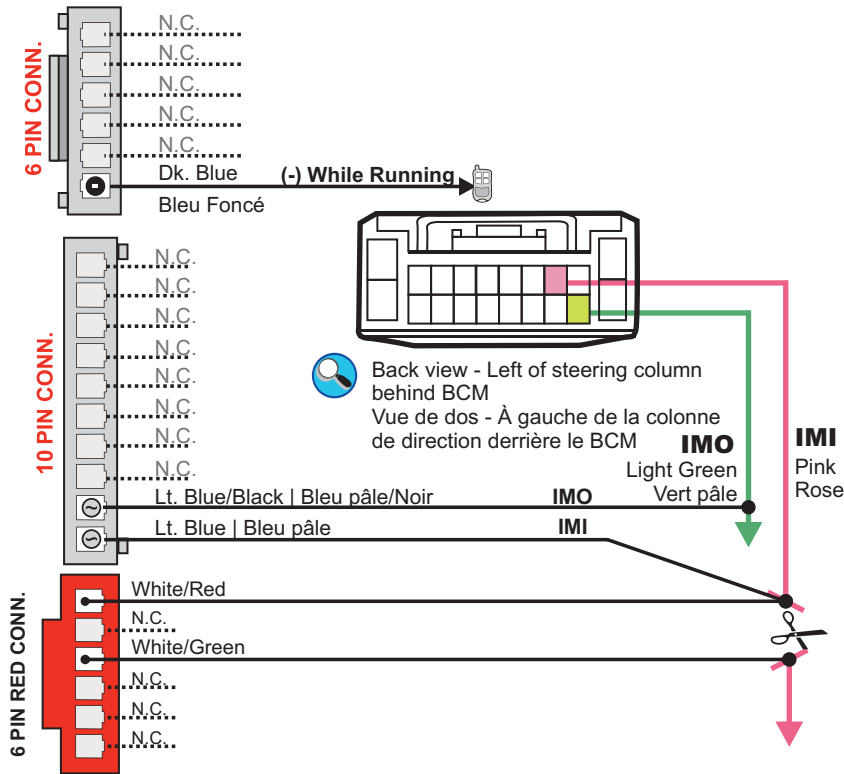

RAV4 CONTINUED | SUITE



DO NOT use a standard test-light on these circuits. Only use a computer-safe test-light or logic probe. | Ne jamais utilisez de test-light pour les tests. Utilisez computer-safe test-light ou une probe logique.

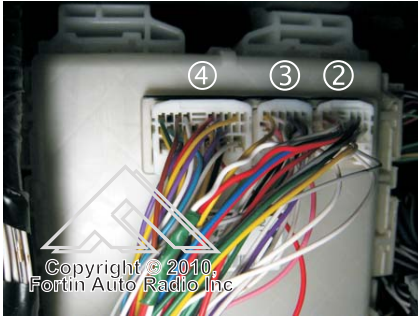

BCM Back view - BCM Vue de dos

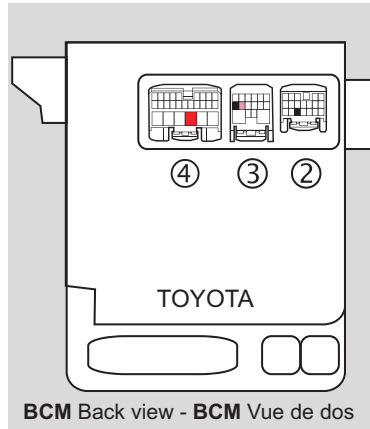

BCM Back view - BCM Vue de dos

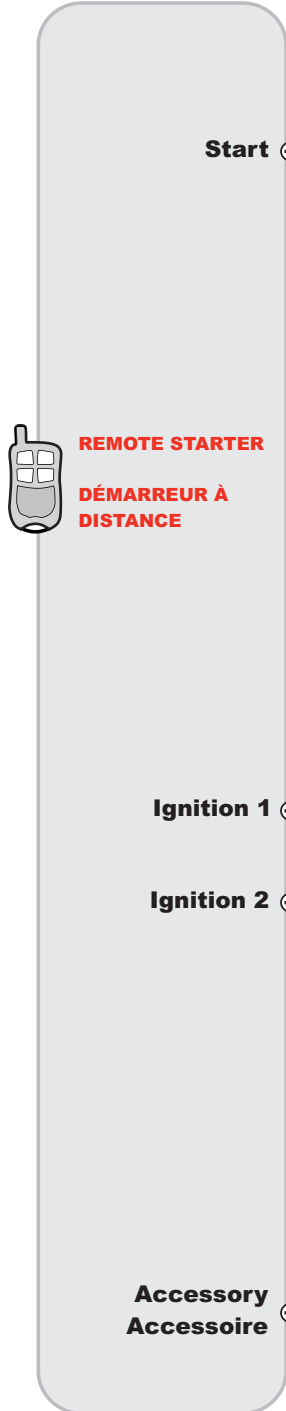
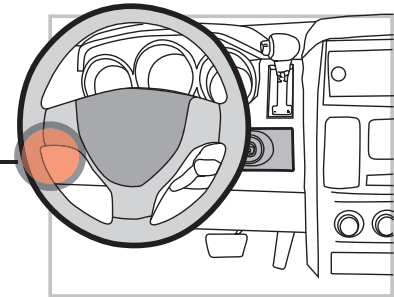

REMOTE STARTER
DÉMARREUR À DISTANCE

Start ⊕

White
Blanc

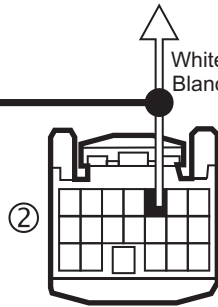

Back view -
Left of steering column
behind BCM'

Vue de dos -
À gauche de la colonne
de direction derrière le BCM

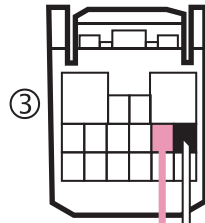
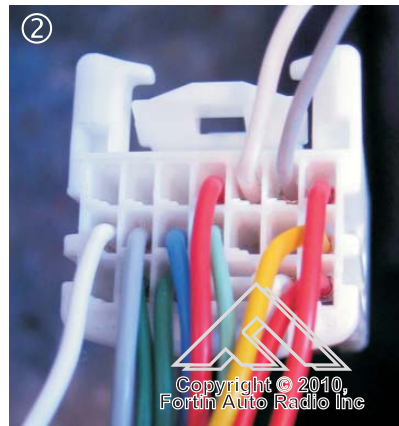

Back view -
Left of steering column
behind BCM'

Vue de dos -
À gauche de la colonne
de direction derrière le BCM

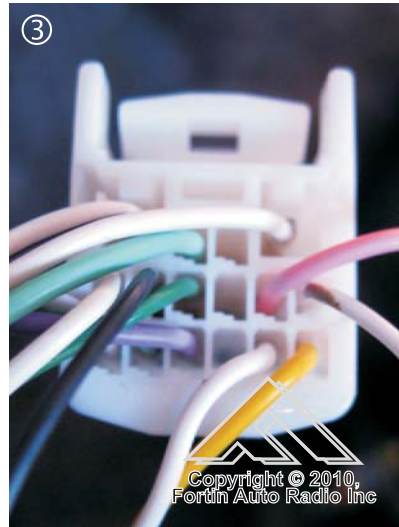

Ignition 1 ⊕

Pink
or
Purple
Rose
ou
Mauve

White
Blanc

Ignition 2 ⊕

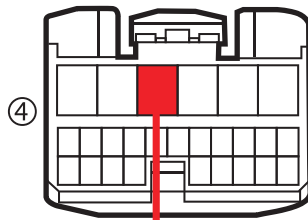

Back view -
Left of steering column
behind BCM'

Vue de dos -
À gauche de la colonne
de direction derrière
le BCM



Accessory
Accessoire ⊕

Red
Rouge

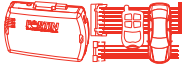

RAV4 CONTINUED | SUITE

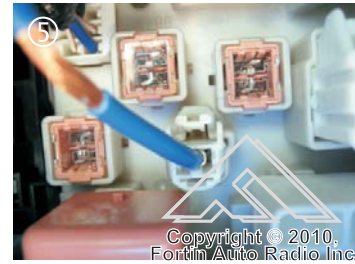
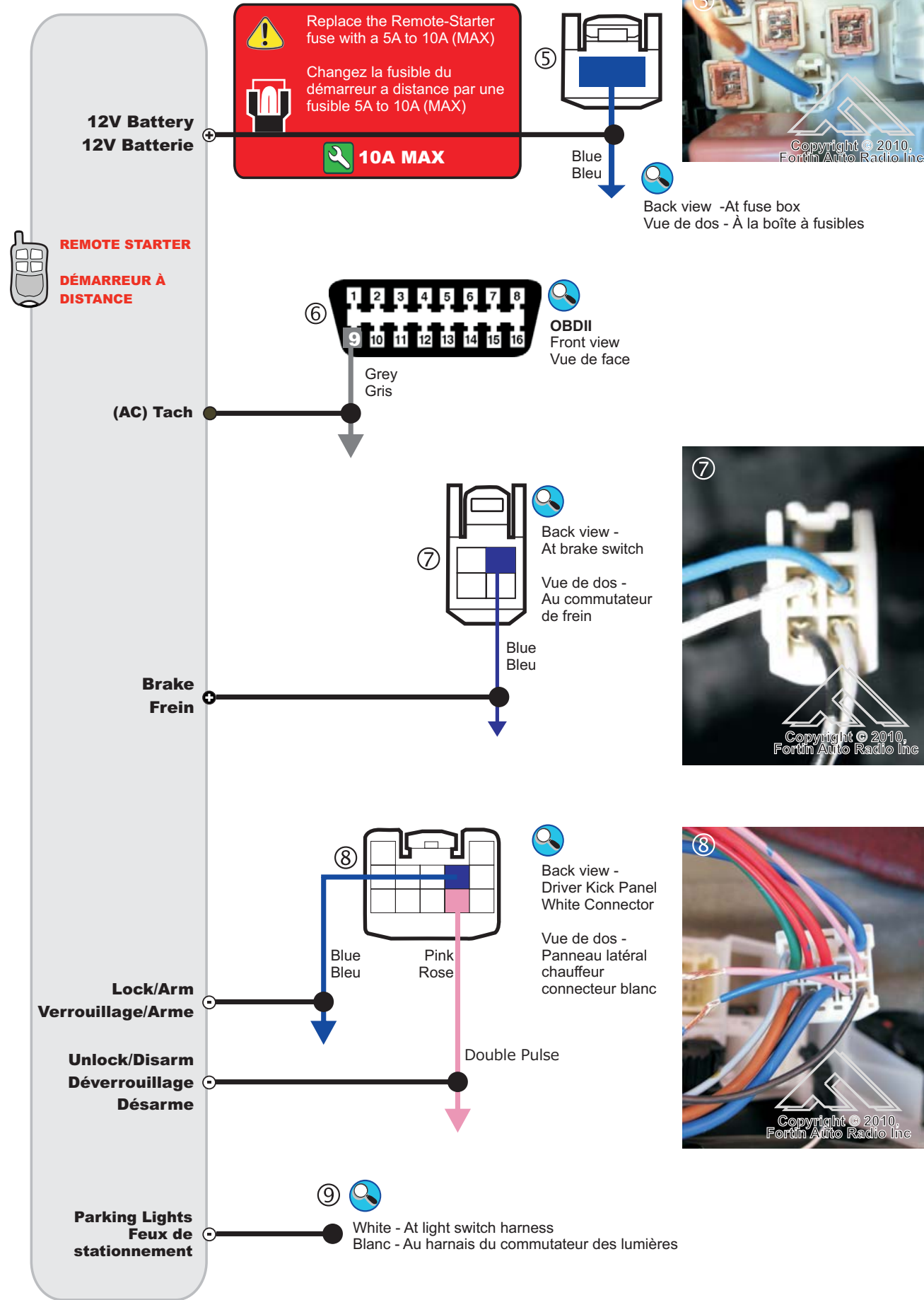

Back view - At fuse box
Vue de dos - À la boîte à fusibles

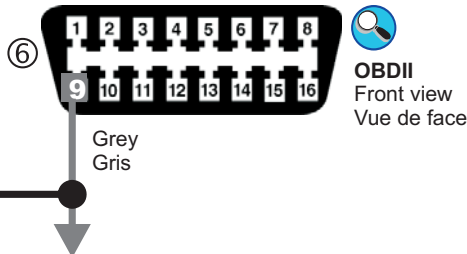

OBDII
Front view
Vue de face

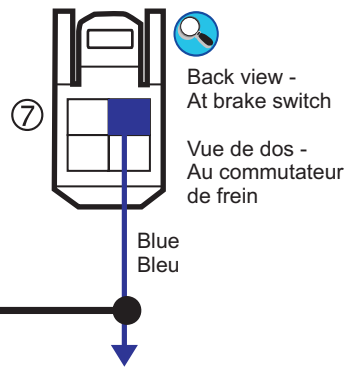

Back view - At brake switch
Vue de dos - Au commutateur de frein

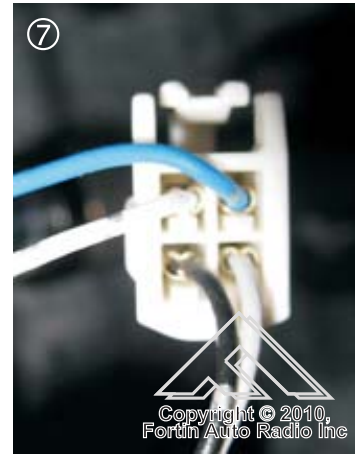

7

Copyright © 2010, Fortin Auto Radio Inc

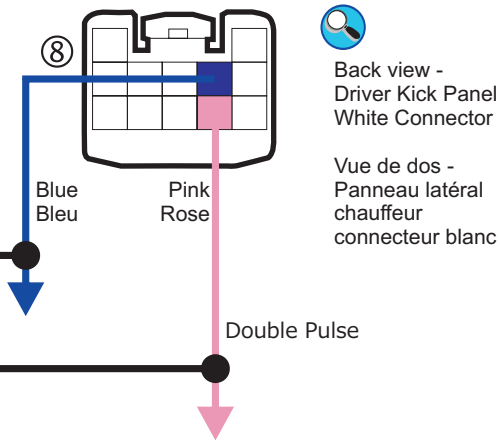

Back view - Driver Kick Panel White Connector
Vue de dos - Panneau latéral chauffeur connecteur blanc



8

Copyright © 2010, Fortin Auto Radio Inc

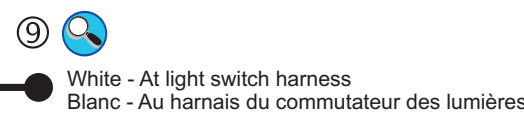

White - At light switch harness
Blanc - Au harnais du commutateur des lumières

9

PROGRAMMING PROCEDURE | PROCÉDURE DE PROGRAMMATION

1



Press and hold the programming button:

Pressez le bouton de programmation:



Insert the connectors in the following order:

Insérez les connecteurs dans l'ordre suivant:

2

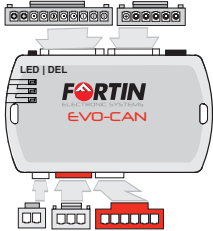

Insert the remaining connectors:

- 20 pin connector (White)
- 6 pin connector (Red)
- 5 pin connector (White)
- 2 pin connector (White)
- * If required.

Insérez les connecteurs restants:

- connecteur 20 pins (Blanc).
- connecteur 6 pins (Rouge).
- connecteur 5 pins (Blanc)
- connecteur 2 pins (Blanc).
- * Si requis.

3



Insert the 4 Pin (Data-Link) connector into the EVO-CAN module.

Insérez le connecteur 4 pins (Data-Link) dans le EVO-CAN.

4

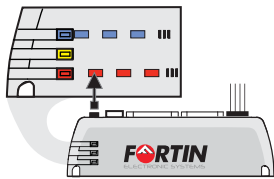

The LED will alternate between BLUE and RED flashes.

Les DELS alternent entre un flash BLEU et ROUGE,

Release the programming button when the LED is RED.

relâchez le bouton de programmation quand la DEL est ROUGE.

If the LED is not solid RED disconnect the 4 Pin connector (Data-Link) and go back to step 3

Si le DEL n'est pas ROUGE débranchez le connecteur 4 pins (Data-Link) et allez à l'étape 3

4



Press on the brake pedal and **Press** the Push-to-Start button once to start the engine.

Appuyer sur la pédale de frein et **Appuyez** 1 fois sur le bouton démarrage (Push-to-Start) pour démarrer le moteur

5

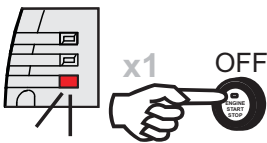

Once the Red LED starts to flash rapidly **press** the Push-to-Start button once to shut off the ignition.

Lorsque le DEL Rouge clignote rapidement, **appuyez** une fois sur le bouton démarrage (Push-to-Start) pour éteindre l'ignition.

The Red LED will turn off to indicate the module has been programmed.

Le DEL rouge s'éteint pour indiquer que le module est programmé.

REMOTE STARTER FUNCTIONALITY | FONCTIONNALITÉS DU DÉMARREUR À DISTANCE



Remote start the vehicle.

Démarrez à distance.

Enter the vehicle with the Intelli-Key and **press** the Push to Start button twice.

Entrez dans le véhicule avec la clé intelligente (Intelli-Key), **appuyez** 2 fois sur le bouton démarrage (Push-to-Start) du véhicule.

The vehicle can now be put in to gear and driven.

Vous êtes maintenant prêt à embrayer et prendre la route.

EVO-CAN

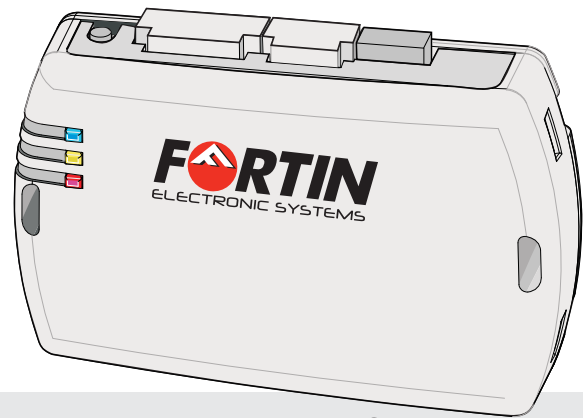

Module label | Étiquette sur le module

Notice: Updated Firmware and Installation Guides

Updated firmware and installation guides are posted on our web site on a regular basis. We recommend that you update this module to the latest firmware and download the latest installation guide(s) prior to the installation of this product.

Des mises à jour du Firmware (microprogramme) et des guides d'installation sont mises en ligne régulièrement. Vérifiez que vous avez bien la dernière version logiciel et le dernier guide d'installation avant l'installation de ce produit.

WARNING / TECH SUPPORT / MISE EN GARDE / SUPPORT TECHNIQUE

The information on this sheet is provided on an (as is) basis with no representation or warranty of accuracy whatsoever. It is the sole responsibility of the installer to check and verify any circuit before connecting to it. Only a computer safe logic probe or digital multimeter should be used. FORTIN ELECTRONIC SYSTEMS assumes absolutely no liability or responsibility whatsoever pertaining to the accuracy or currency of the information supplied. The installation in every case is the sole responsibility of the installer performing the work and FORTIN ELECTRONIC SYSTEMS assumes no liability or responsibility whatsoever resulting from any type of installation, whether performed properly, improperly or any other way. Neither the manufacturer or distributor of this module is responsible of damages of any kind indirectly or directly caused by this module, except for the replacement of this module in case of manufacturing defects. This module must be installed by qualified technician. The information supplied is a guide only. This instruction guide may change without notice. **Visit www.fortinbypass.com to get the latest version.**

L'information de ce guide est fournie sur la base de représentation (telle quelle) sans aucune garantie de précision et d'exactitude. Il est de la seule responsabilité de l'installateur de vérifier tous les fils et circuit avant défectuer les connections. Seule une sonde logique ou un multimètre digital doivent être utilisés. FORTIN SYSTÈMES ÉLECTRONIQUES n'assume aucune responsabilité de l'exactitude de l'information fournie. L'installation (dans chaque cas) est la responsabilité de l'installateur effectuant le travail. FORTIN SYSTÈMES ÉLECTRONIQUES n'assume aucune responsabilité suite à l'installation, que celle-ci soit bonne ou mauvaise ou de n'importe autre type. Ni le fabricant, ni le distributeur ne se considèrent responsables des dommages causés ou ayant pu être causés, indirectement ou directement, par ce module, excepté le remplacement de ce module en cas de défectuosité de fabrication. Ce module doit être installé par un technicien qualifié. L'information fournie dans ce guide est une suggestion. Ce guide d'instruction peut faire l'objet de changement sans préavis. **Consultez le www.fortinbypass.com pour voir la plus récente version.**

Copyright © 2006-2010, FORTIN AUTO RADIO INC ALL RIGHTS RESERVED **PATENT PENDING**



TECH SUPPORT

Tél: 514-255-HELP (4357)
1-877-336-7797



ADDENDUM GUIDE

www.fortinbypass.com

WEB UPDATE | MISE À JOUR INTERNET

