

CHRYSLER, DODGE, JEEP

Functional if equipped | Fonctionnelle si le véhicule en est équipé.



VEHICLE VEHICULES	YEARS ANNÉES	Lock	Unlock	Arm	Disarm	Hatch (open)	Trunk (open)	Sliding Door	Window Roll Down	Gas Door	RAP Disable	Parking Light	Memory Driver	Tachometer	Heated Seats	Heated Mirrors	Rear Defrost	Door Status	Trunk Status	Hood Status	Hand-Brake Status	Foot-Brake Status	Transponder Bypass	PK3, Passlock	
CHRYSLER																									
300-300C	2005-2007	•	•	•	•	•	•				•			•				•	•	•	•	•	•		
PT Cruiser	2008-2010	•	•	•	•	•	•							•				•	•	•	•	•	•	•	
Sebring	2007	•	•	•	•	•	•				•			•				•	•	•	•	•	•	•	
DODGE																									
Caliber	2007	•	•	•	•	•	•				•			•				•	•	•	•	•	•	•	
Charger	2006-2007	•	•	•	•	•	•				•			•				•	•	•	•	•	•	•	
Magnum	2005-2008	•	•	•	•	•	•				•			•				•	•	•	•	•	•	•	
RAM	2006-2007	•	•	•	•	•	•				•			•				•	•	•	•	•	•	•	
JEEP																									
Commander	2006-2007	•	•	•	•	•	•				•			•				•	•	•	•	•	•	•	
Compass	2007	•	•	•	•	•	•				•			•				•	•	•	•	•	•	•	
Grand Cherokee	2005-2007	•	•	•	•	•	•				•			•				•	•	•	•	•	•	•	
Patriot	2007	•	•	•	•	•	•				•			•				•	•	•	•	•	•	•	
Wrangler	2007	•	•	•	•	•	•				•			•				•	•	•	•	•	•	•	



Module label | Étiquette sur le module

Notice: Updated Firmware and Installation Guides

Updated firmware and installation guides are posted on our web site on a regular basis. We recommend that you update this module to the latest firmware and download the latest installation guide(s) prior to the installation of this product.

Notice: Mise à jour microprogramme et Guides d'installations

Des mises à jour du Firmware (microprogramme) et des guides d'installation sont mis en ligne régulièrement. Vérifiez que vous avez bien la dernière version logiciel et le dernier guide d'installation avant l'installation de ce produit.



TECH SUPPORT

Tél: 514-255-HELP (4357)
1-877-336-7797

www.fortinbypass.com

WEB UPDATE | MISE À JOUR INTERNET



ADDENDUM GUIDE

Rev : 20120717

DESCRIPTION | DESCRIPTIONS

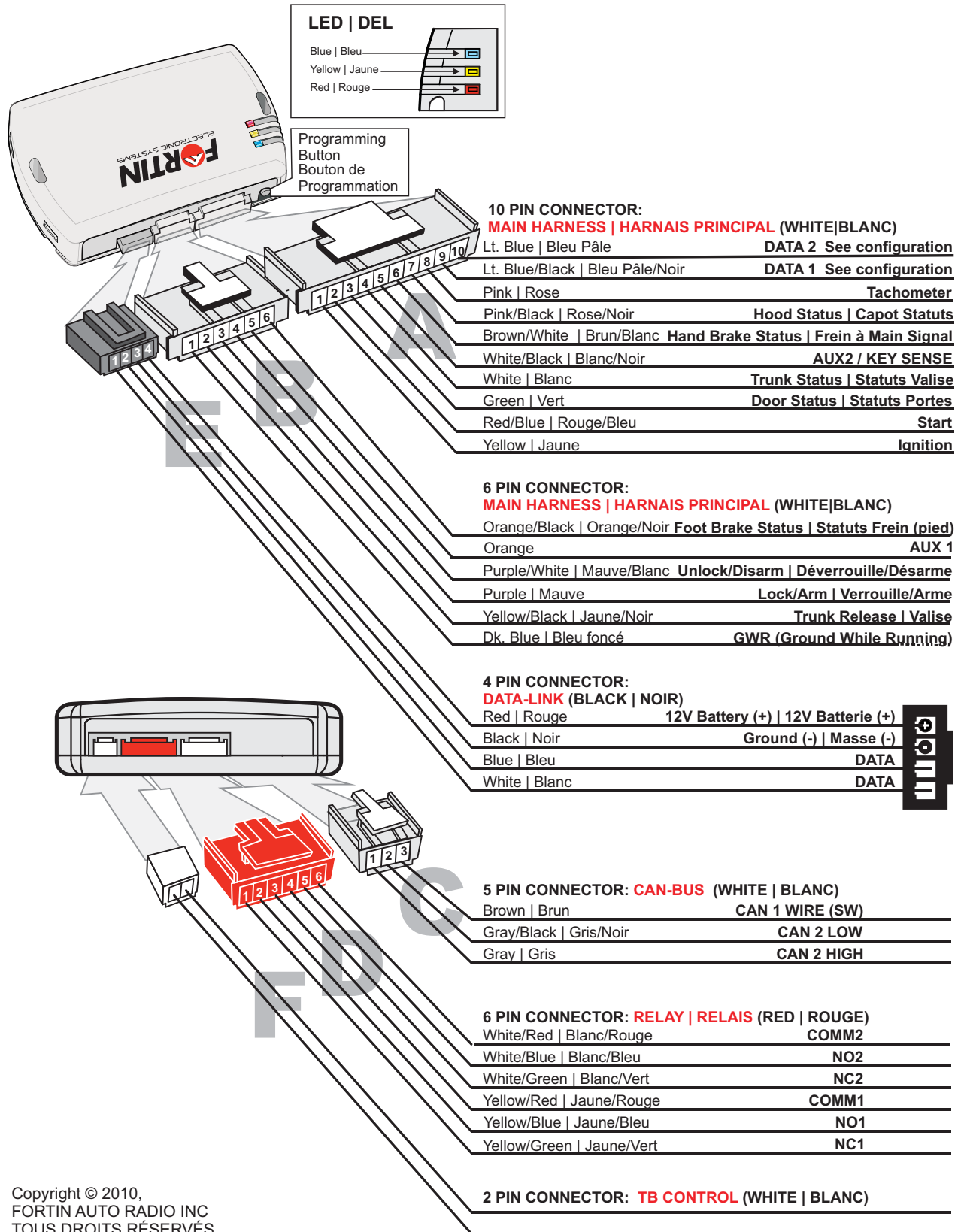

CONNECTION GUIDE | GUIDE DE BRANCHEMENTS

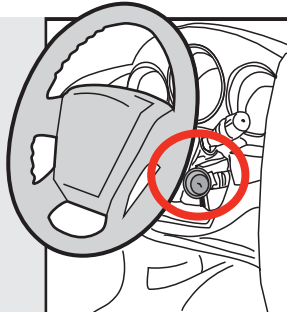
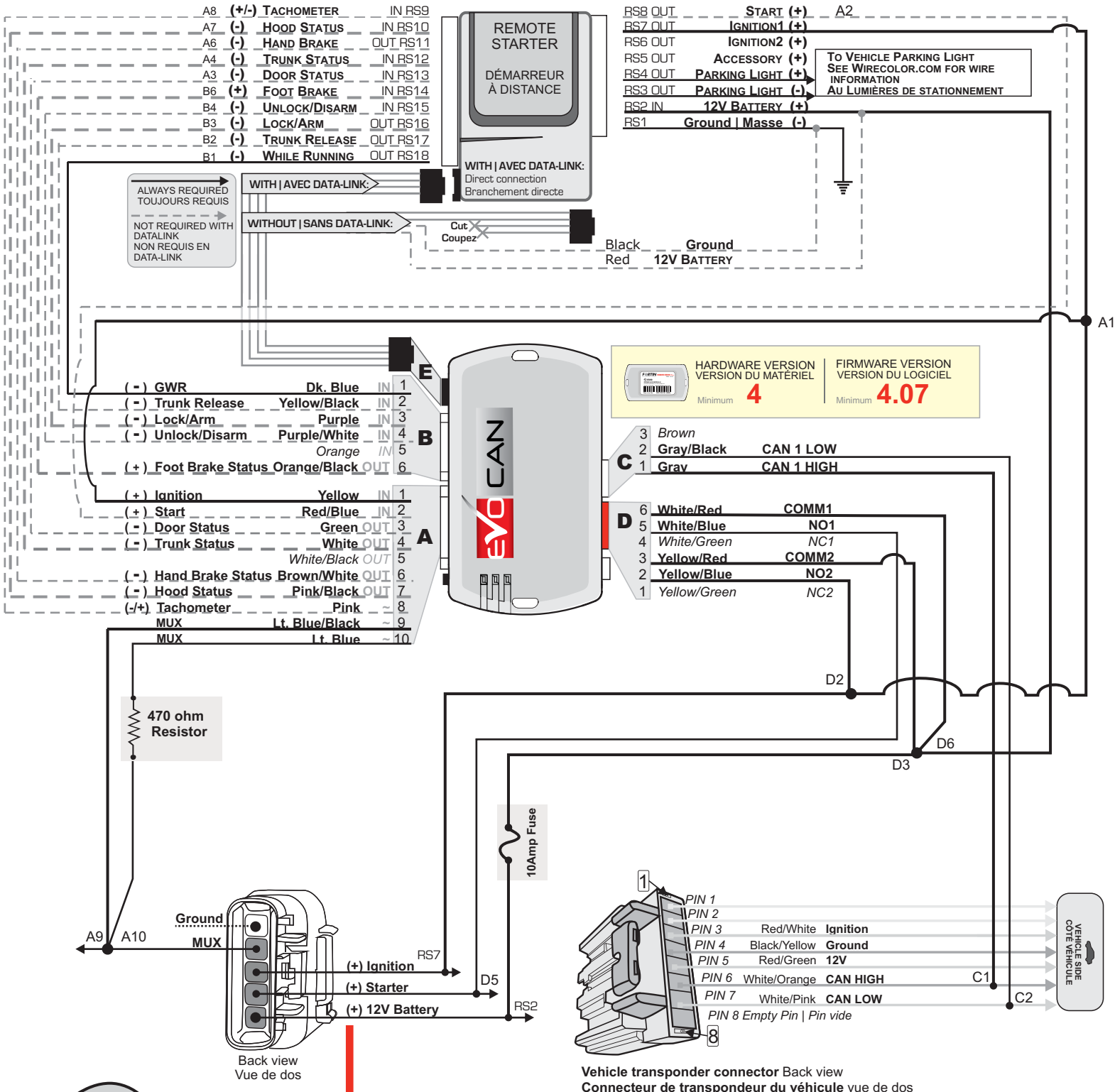

Key cylinder
Barillet de la clé

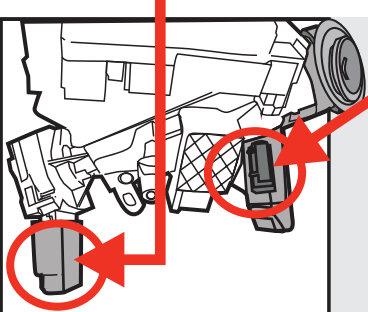









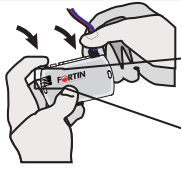
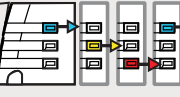
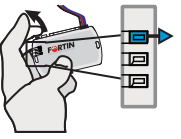

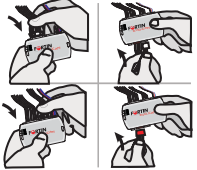
Key cylinder
Barillet de la clé

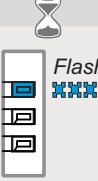

CAUTION
Take care when disconnecting the harness from the ignition barrel. It is very fragile and can easily break.
ATTENTION Débranchez le connecteur d'ignition avec précaution le module de l'immobilisateur est fragile.

PROGRAMMING PROCEDURE | PROCEDURE DE PROGRAMMATION

<p>1</p>  <p>Press and hold the programming button:</p> <p>Appuyez et maintenez enfoncé le bouton de programmation:</p>	 <p>Insert the 4 Pin (Data-Link) connector.</p> <p>Insérez le connecteur 4 pins (Data-Link).</p>	 <p>The LED's will alternate between BLUE, YELLOW and RED flashes. <i>Les DELS alternent entre un flash BLEU, JAUNE et ROUGE.</i></p>	 <p>Release the programming button when the LED is BLUE.</p> <p>Relâchez le bouton de programmation quand la DEL est BLEU.</p>	<p>▶▶▶</p> <p>If the LED is not solid BLUE disconnect the 4 Pin connector (Data-Link) and go back to beginning of step 1. Si le DEL n'est pas BLEU solide débranchez le connecteur 4 pins (Data-Link) et allez au début de l'étape 1.</p> 	<p>2</p>  <p>Insert the remaining required connectors: 10 pin (White), 2 pin (White), 6 pin (White), 6 pin (Red), 3 pin (White).</p> <p>Insérez les connecteurs requis restants: 10 pins (Blanc), 2 pins (Blanc), 6 pins (Blanc), 6 pins (Rouge), 3 pins (Blanc).</p>
<p>3</p>  <p>Turn the Ignition to the ON/RUN position.</p> <p>Tournez la clef en position ignition (ON).</p>	 <p>The BLUE LED will flash rapidly.</p> <p><i>La DEL BLEU clignotera rapidement.</i></p>	 <p>Turn the Ignition to the OFF position.</p> <p>Tournez la clef à OFF.</p>	 <p>The BLUE LED will flash rapidly.</p> <p><i>La DEL BLEU clignotera rapidement.</i></p>	<p>5 With OEM remote Or Ou Without OEM remote</p> <p>Avec Télécommande d'origine Sans Télécommande d'origine</p> <div style="display: flex; justify-content: space-around;"> <div data-bbox="1031 724 1242 871">  <p>Press the LOCK button on the vehicles OEM remote.</p> <p>Appuyez sur le bouton Verrouillage de la télécommande d'origine du véhicule.</p> </div> <div data-bbox="1250 724 1461 871">  <p>Press and release the programming button on the EVO once.</p> <p>Appuyez sur le bouton de programmation du module EVO.</p> </div> </div>	
 <p>The BLUE LED will turn off.</p> <p><i>Le DEL BLEU s'éteint.</i></p>		 <p>The module is now programmed.</p> <p><i>Le module est programmé.</i></p>			

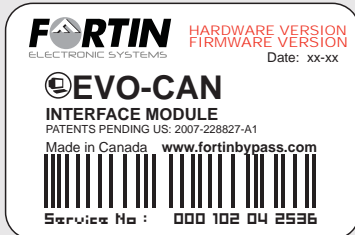

Module label | Étiquette sur le module

Notice: Updated Firmware and Installation Guides

Updated firmware and installation guides are posted on our web site on a regular basis. We recommend that you update this module to the latest firmware and download the latest installation guide(s) prior to the installation of this product.

Notice: Mise à jour microprogramme et Guides d'installations

Des mises à jour du Firmware (microprogramme) et des guides d'installation sont mis en ligne régulièrement. Vérifiez que vous avez bien la dernière version logiciel et le dernier guide d'installation avant l'installation de ce produit.

WARNING

The information on this sheet is provided on an (as is) basis with no representation or warranty of accuracy whatsoever. It is the sole responsibility of the installer to check and verify any circuit before connecting to it. Only a computer safe logic probe or digital multimeter should be used. FORTIN ELECTRONIC SYSTEMS assumes absolutely no liability or responsibility whatsoever pertaining to the accuracy or currency of the information supplied. The installation in every case is the sole responsibility of the installer performing the work and FORTIN ELECTRONIC SYSTEMS assumes no liability or responsibility whatsoever resulting from any type of installation, whether performed properly, improperly or any other way. Neither the manufacturer or distributor of this module is responsible of damages of any kind indirectly or directly caused by this module, except for the replacement of this module in case of manufacturing defects. This module must be installed by qualified technician. The information supplied is a guide only. This instruction guide may change without notice. Visit www.fortinbypass.com to get the latest version.

MISE EN GARDE

L'information de ce guide est fournie sur la base de représentation (telle quelle) sans aucune garantie de précision et d'exactitude. Il est de la seule responsabilité de l'installateur de vérifier tous les fils et circuit avant défectuer les connexions. Seule une sonde logique ou un multimètre digital doivent être utilisés. FORTIN SYSTÈMES ÉLECTRONIQUES n'assume aucune responsabilité de l'exactitude de l'information fournie. L'installation (dans chaque cas) est la responsabilité de l'installateur effectuant le travail. FORTIN SYSTÈMES ÉLECTRONIQUES n'assume aucune responsabilité suite à l'installation, que celle-ci soit bonne ou mauvaise ou de n'importe autre type. Ni le manufacturier, ni le distributeur ne se considèrent responsables des dommages causés ou ayant pu être causés, indirectement ou directement, par ce module, excepté le remplacement de ce module en cas de défectuosité de fabrication. Ce module doit être installé par un technicien qualifié. L'information fournie dans ce guide est une suggestion. Ce guide d'instruction peut faire l'objet de changement sans préavis. Consultez le www.fortinbypass.com pour voir la plus récente version.

Copyright © 2006-2012, FORTIN AUTO RADIO INC ALL RIGHTS RESERVED PATENT PENDING



TECH SUPPORT

Tél: 514-255-HELP (4357)
1-877-336-7797



ADDENDUM GUIDE

www.fortinbypass.com

WEB UPDATE | MISE À JOUR INTERNET

