

**THAR-NIS1**
**THARNNESS STAND ALONE INSTALLATION  
INSTALLATION HARNAIS STAND ALONE**

 ADDENDUM - SUGGESTED WIRING CONFIGURATION  
ADDENDA - SCHÉMA DE BRANCHEMENT SUGGÉRÉ

**ONLY COMPATIBLE WITH AUTOMATIC TRANSMISSION VEHICLES.  
COMPATIBLE AVEC VÉHICULE À TRANSMISSION AUTOMATIQUE SEULEMENT.**

**Vehicle functions supported in this diagram (functional if equipped) | Fonctions du véhicule supportées dans ce diagramme (fonctionnelles si équipé)**

VEHICLE VEHICULES	YEARS ANNÉES	Immobilizer bypass Contournement d'immobilisateur	T-Harness Harnais en T	Lock	Unlock	Arm	Disarm	RAP Disable	Parking Light	Tachometer	Door Status	Trunk Status	Hood Status*	Hand-Brake Status	Foot-Brake Status	OEM Remote monitoring	Push-to-Start Control
<b>NISSAN</b>																	
Juke	Push-to-Start- AT 2011-2017	•	•	•	•	•	•	•	•	•	•	•	•	•	•	•	•

 FIRMWARE VERSION  
VERSION LOGICIELLE

**72.[43]**

NISSAN/INFINITI MINIMUM

 To add the firmware version and the options, use the **FLASH LINK UPDATER** or **FLASH LINK MOBILE** tool, sold separately.

 Pour ajouter la version logicielle et les options, utilisez l'outil **FLASH LINK UPDATER** ou **FLASH LINK MOBILE**, vendu séparément.

**Program bypass option:  
Programmez l'option du contournement:**
**UNIT OPTION  
OPTION UNITE**
**DESCRIPTION**
**C1**

OEM Remote status (Lock/Unlock) monitoring

Suivi des status (Verrouillage/Déverrouillage) de la télécommande d'origine

**D6**

Push-to-Start

Push-to-Start

**IF THE VEHICLE IS NOT EQUIPPED  
WITH FUNCTIONAL HOOD PIN:  
SI LE VÉHICULE N'EST PAS ÉQUIPÉ  
D'UN CONTACT DE CAPOT FONCTIONNEL:**
**A11**
**OFF  
NON**

Hood trigger (Output Status).

Contact de capot (état de sortie).

**NOTES**

The vehicles OEM remote and SmartKey are still operable during remote start.

La télécommande d'origine du véhicule et la clé intelligente reste fonctionnel même si le démarreur est engagé.

**Parts required (Not included)**

 1X Fuse  
1X multimeter  
1X Diode

**Pièce(s) requise(s) (Non include(s))**

 1X Fusible  
1X Multimètre  
1X Diode

**MANDATORY INSTALL | INSTALLATION OBLIGATOIRE**
**\*HOOD PIN**

**HOOD STATUS:** THE HOOD PIN SWITCH MUST BE INSTALLED IF THE VEHICLE CAN BE REMOTE STARTED WITH THE HOOD OPEN, SET FUNCTION A11 TO OFF.

**A11**
**OFF  
NON**
**CONTACT DE CAPOT**
**STATUT DE CAPOT:** LE CONTACT DE CAPOT, DOIT ÊTRE INSTALLÉ SI LE VÉHICULE PEUT DÉMARRER À DISTANCE, LORSQUE LE CAPOT EST OUVERT, PROGRAMMEZ LA FONCTION A11 À NON.

**Notice:** the installation of safety elements are mandatory. The hood pin is an essential security element and must be installed.

**Notice:** l'installation des éléments de sécurité est obligatoire. Le contact de capot est un élément de sécurité essentiel et doit absolument être installé.

THIS MODULE MUST BE INSTALLED BY A QUALIFIED TECHNICIAN. A WRONG CONNECTION CAN CAUSE PERMANENT DAMAGE TO THE VEHICLE.

CE MODULE DOIT ÊTRE INSTALLÉ PAR UN TECHNICIEN QUALIFIÉ, TOUTE ERREUR DANS LES BRANCHEMENTS PEUT OCCASIONNER DES DOMMAGES PERMANENTS AU VÉHICULE.

**PARTS REQUIRED (NOT INCLUDED) | PIÈCES REQUISES (NON INCLUSES)**

1x **FLASH LINK UPDATER, FLASH LINK MANAGER**  
SOFTWARE | PROGRAMME  
Microsoft Windows Computer with Internet connection  
Ordinateur Microsoft Windows avec connection Internet

OR

1x **FLASH LINK MOBILE, FLASH LINK MOBILE APP**  
Smartphone *Android* or *iOS* with Internet connection (*provider charges may apply*).  
Téléphone Intelligent *Android* ou *iOS* avec connection Internet (*frais du fournisseur Internet peuvent s'appliquer*).

**MANDATORY | OBLIGATOIRE**

HOOD PIN  
CONTACT DE CAPOT

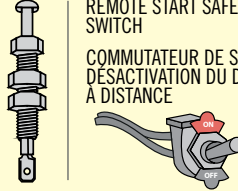

REMOTE START SAFETY OVERRIDE SWITCH  
COMMUNTEUR DE SÉCURITÉ DE DÉSACTIVATION DU DÉMARREUR À DISTANCE





VALET SWITCH  
COMMUNTEUR VALET

Part #: RSPB available, Sold separately.  
Pièce #: RSPB disponible, vendu séparément.

**Notice:** the installation of safety elements are mandatory. The hood pin and the valet switch are essential security elements and must be installed.

**Notice:** l'installation des éléments de sécurité est obligatoire. Le contact de capot et le commutateur de valet sont des éléments de sécurité essentiels et doivent absolument être installés.

**STAND ALONE CONFIGURATION | CONFIGURATION EN DÉMARREUR AUTONOME**

	Program bypass option	UNIT OPTION OPTION UNITE	DESCRIPTION
	<b>OEM Remote Stand Alone Remote Starter:</b> Programmez l'option du contournement Démarreur à distance Autonome avec télécommande d'origine :	<b>D1.10</b> 	<b>By default, LOCK, LOCK, LOCK</b> Par défaut, VERROUILLE,VERROUILLE,VERROUILLE
		<b>D1.1</b> 	LOCK, UNLOCK, LOCK VERROUILLE,DÉVERROUILLE,VERROUILLE
	<b>Program bypass option with oem remote:</b> Programmez l'option du contournement avec télécommande d'origine:	<b>C1</b>	OEM Remote Monitoring
			Supervision de la télécommande d'origine
	<b>Program bypass option with RF KIT antenna:</b> Programmez l'option du contournement avec antenne RF:	<b>H1 to H6 H1 à H6</b>	Supported RF Kits and <b>select RF Kit</b>
			Kit RF supportés et <b>sélectionnez le KIT RF</b>

**REMOTE STARTER FUNCTIONALITY | FONCTIONNALITÉS DU DÉMARREUR À DISTANCE**



All doors must be closed.  
Toutes les portes doivent être fermées

**3X** 

Press the OEM remote's Lock button 3x to remote-start (or remote-stop) the vehicle.  
Appuyez sur le bouton Verrouillage 3X de la télécommande d'origine pour démarrer à distance (ou arrêter à distance) le véhicule.



**START** 

The vehicle will START.  
Le véhicule DÉMARRE.

**REMOTE STARTER DIAGNOSTICS  
DIAGNOSTIQUE DU DÉMARREUR À DISTANCE**

MODULE RED LED | DEL ROUGE DU MODULE

<b>x2 flash :</b> Brake ON	Frein Activé
<b>x3 flash :</b> No tach	Pas de Tach
<b>x4 flash :</b> Ignition before start	Clé de contact détectée avant démarrage
<b>x5 flash :</b> Hood Open	Capot Ouvert

**REMOTE STARTER WARNING CARD | CARTE D'AVERTISSEMENT DE DÉMARREUR À DISTANCE**



**CUT THIS WARNING CARD AND STICK IT ON A VISIBLE PLACE:**  
or use the package **RSPB**, Sold separately.  
**COUPEZ CETTE CARTE D'AVERTISSEMENT ET COLLEZ-LA À UN ENDROIT VISIBLE:**  
ou utilisez la trousse **RSPB**, vendue séparément.



**WARNING | ATTENTION**

**REMOTE STARTER  
DÉMARREUR À DISTANCE**

THE VEHICLE CAN BE STARTED BY EITHER: PRESSING THE LOCK BUTTON ON THE OEM REMOTE 3 TIMES CONSECUTIVELY OR BY A SMARTPHONE. **TURN ON THE SAFETY SWITCH** LOCATED UNDER THE DASHBOARD BEFORE WORKING ON THE VEHICLE.

LE VÉHICULE PEUT DÉMARRER SOIT: EN APPUYANT 3 FOIS CONSÉCUTIVEMENT SUR LE BOUTON VERROUILLEMENT DE LA TÉLÉCOMMANDE DU VÉHICULE OU PAR UN TÉLÉPHONE INTELLIGENT. **ACTIONNEZ EN POSITION 'ON'** LE COMMUNTEUR DE SÉCURITÉ SITUÉ SOUS LE TABLEAU DE BORD AVANT LES TRAVAUX D'ENTRETIEN.

DESCRIPTION | DESCRIPTION

⑥ OBD-II Connector  
Connecteur OBD-II



① ② BCM

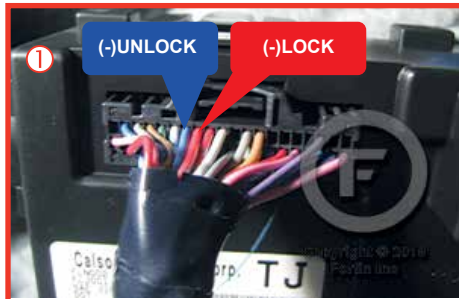

④ ⑤ Back of push-to-start  
Dos du bouton démarrage

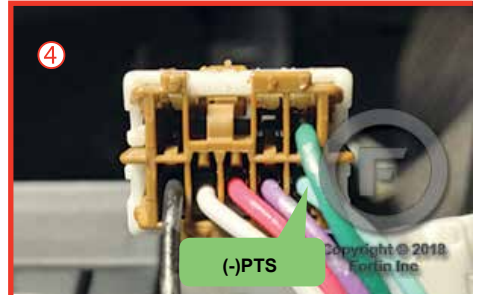

③ Driver lick panel  
Panneau latéral côté conducteur



⑦ At brake switch  
Au commutateur de frein

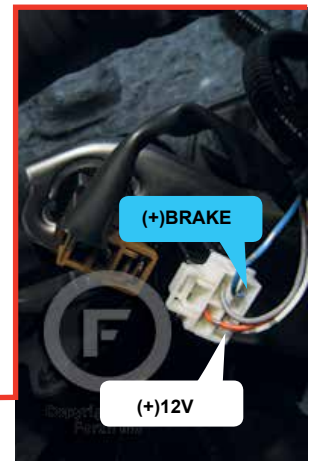

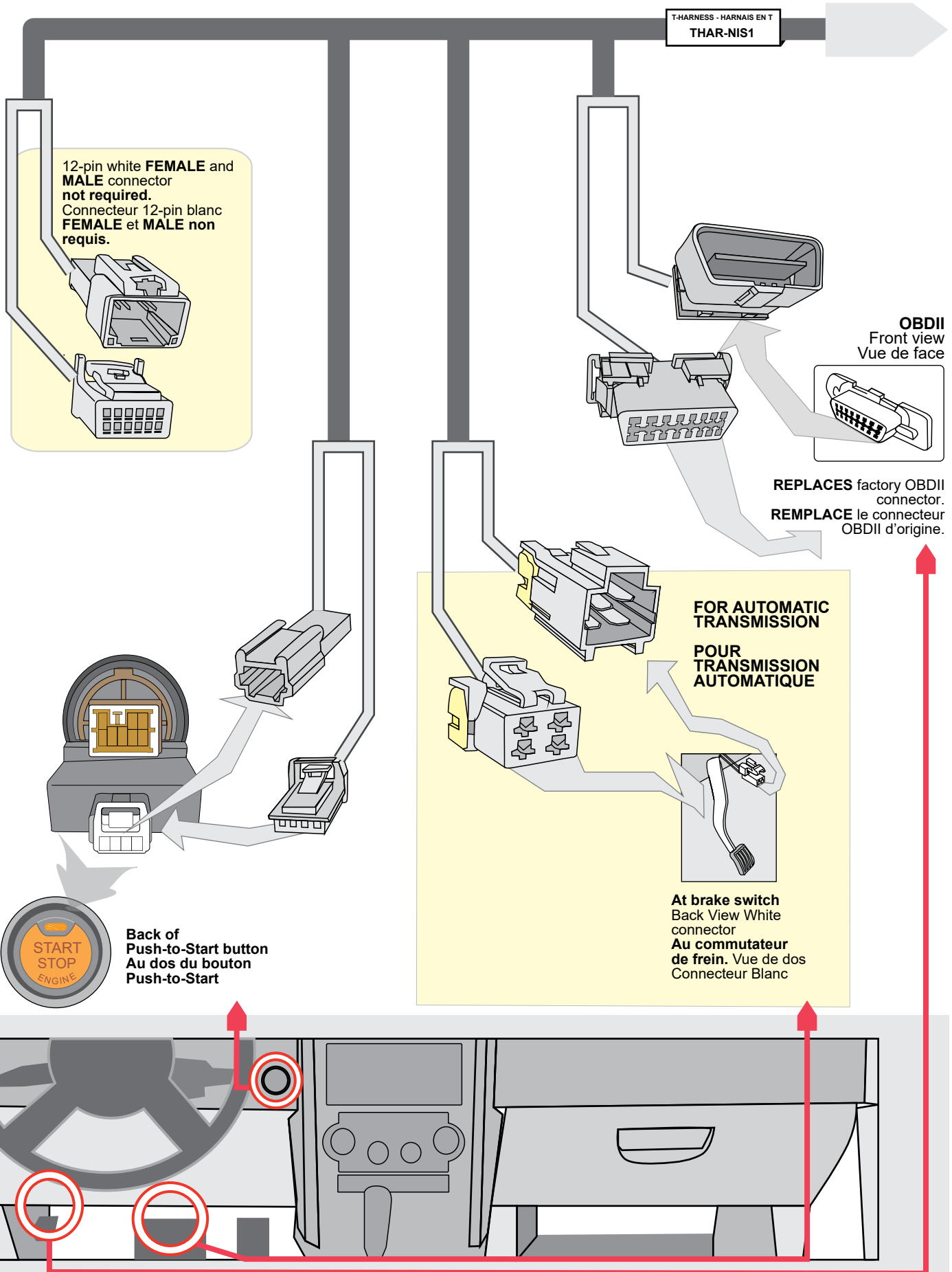

**AUTOMATIC TRANSMISSION WIRING CONNECTION | SCHÉMA DE BRANCHEMENT TRANSMISSION AUTOMATIQUE**

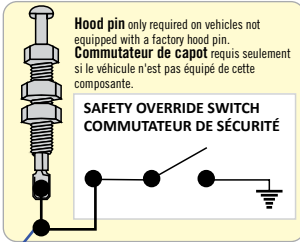

Start / Stop external control  
Contrôle de démarrage/arrêt externe

(-) Lock/Unlock input external control  
Contrôle du verrouillage/déverrouillage entrée externe

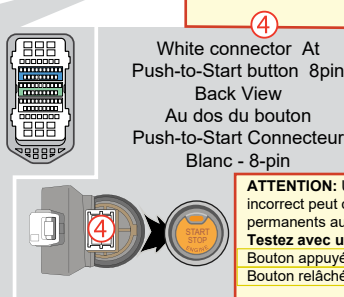
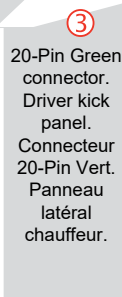
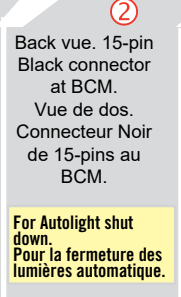
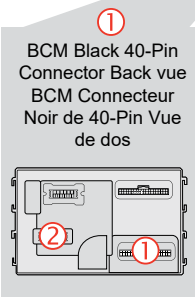
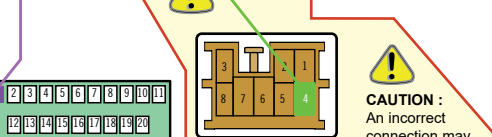
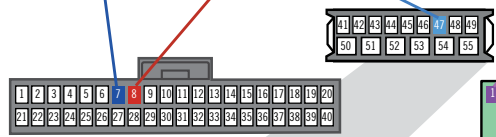
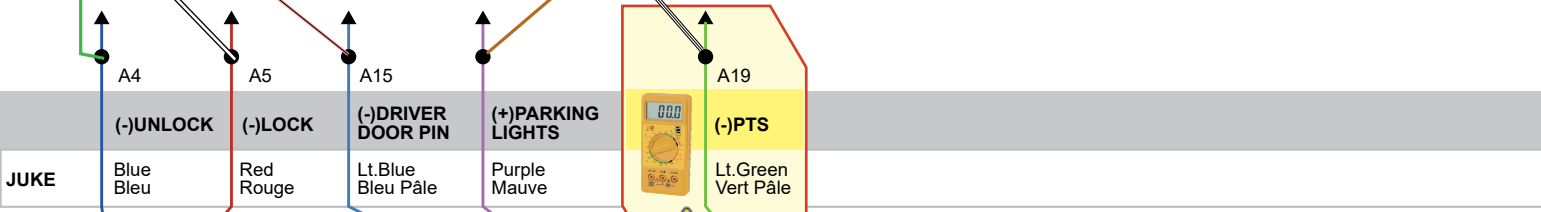
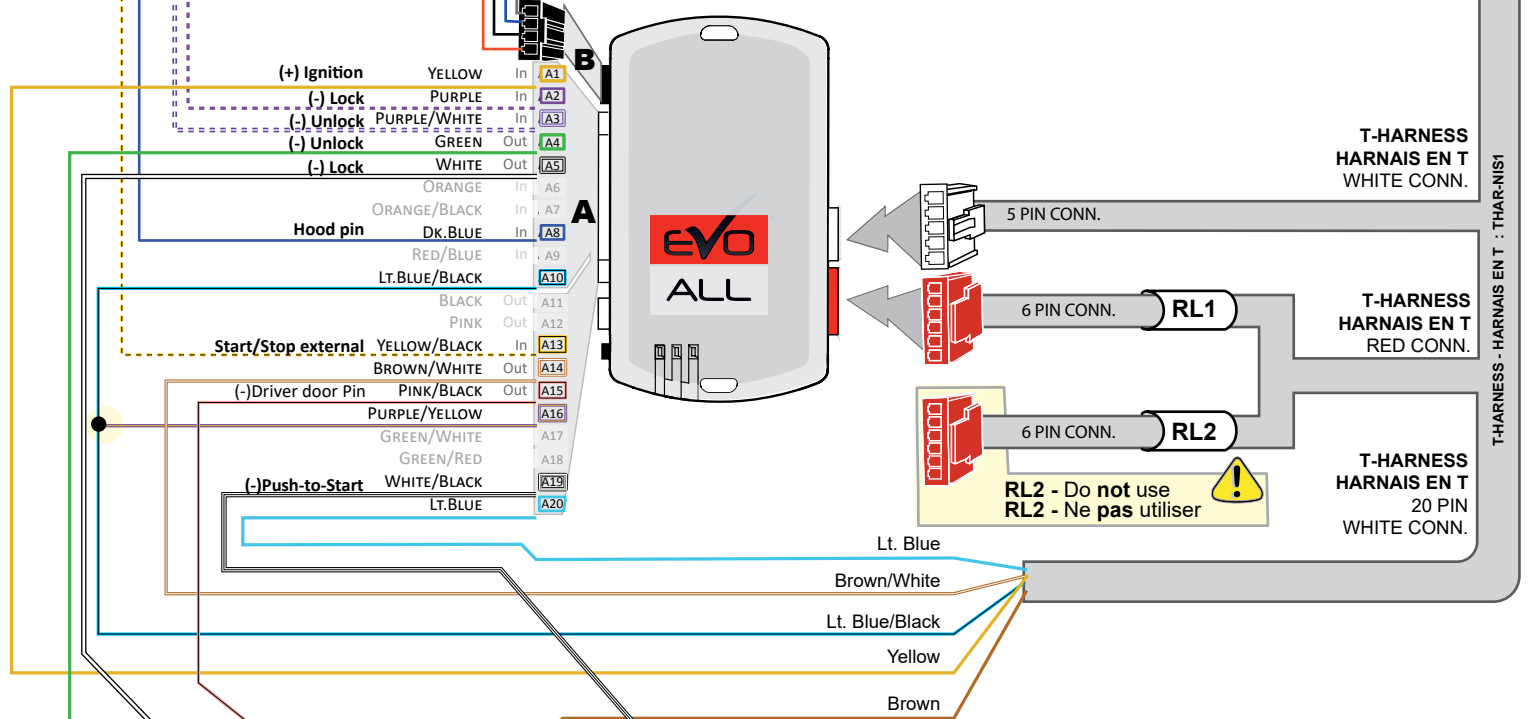
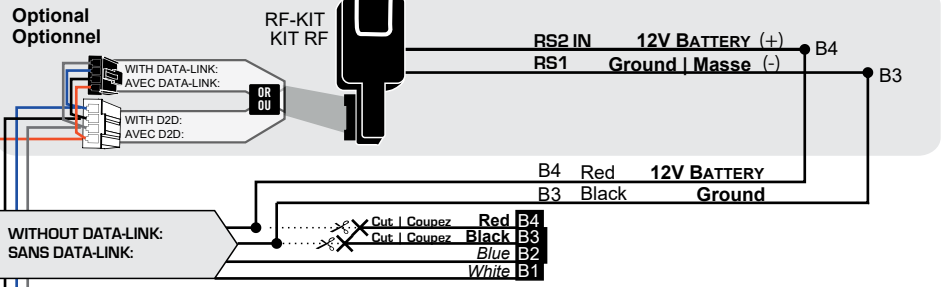

**CAUTION :**  
An incorrect connection may cause permanent damage to the module.  
**Testing the voltage with a multimeter:**  
Button pressed : 0 VDC  
Button release : 12 VDC

**ATTENTION :**  
Un branchement incorrect peut causer des dommages permanents au module.  
**Testez avec un multimètre:**  
Bouton appuyé : 0VDC  
Bouton relâché : 12 VDC

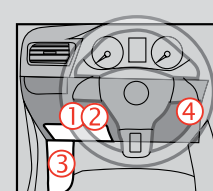

T-HARNESS - HARNAIS EN T : THAR-NIST

**KEY BYPASS PROGRAMMING PROCEDURE 1/2 | PROCÉDURE DE PROGRAMMATION CONTOURNEMENT DE CLÉ 1/2**

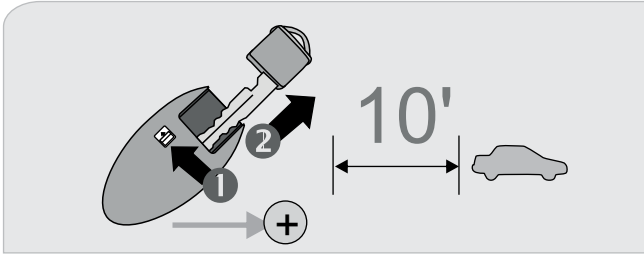

**Remove** the valet key from the back of the OEM remote.  
**Remove** the battery from the OEM remote.  
**Keep** the other OEM remotes at least 3 meters (10 feet) away from the vehicle to proceed.

**Retirez** la clé valet du dos de la télécommande d'origine.  
**Retirez** la pile de la télécommande d'origine.  
**Éloignez** les autres télécommandes d'origine du véhicule (10 pieds / 3 mètres min) pour procéder à la programmation.

**1**

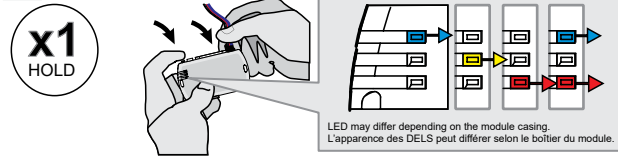

**Press and hold** the programming button:  
**Insert** the 4-Pin (Data-Link) connector.

**Appuyez et maintenir enfoncé** le bouton de programmation:  
**Insérez** le connecteur 4 pins (Data-Link)

↳ The Blue, Red, Yellow and Blue & Red LEDs will alternatively illuminate.

↳ Les DELs Bleue, Rouge, Jaune et Bleue & Rouge s'illumineront alternativement.

**2**

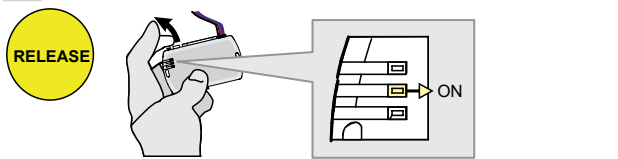

**Release** the programming button when the LED is **YELLOW**.

**Relâchez** le bouton de programmation quand la DEL est **JAUNE**.

If the LED is not solid **YELLOW** **disconnect** the 4-Pin connector (Data-Link) and **go back** to step 1.

Si le DEL n'est pas **JAUNE** **débranchez** le connecteur 4 pins (Data-Link) et **allez** au début de l'étape 1.

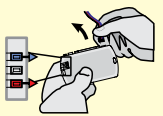

**3**

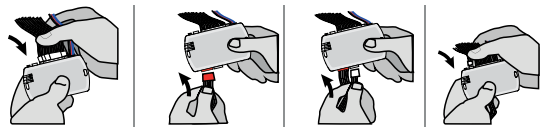

**Insert** the required remaining connectors.

**Insérez** les connecteurs requis restants.

**4**

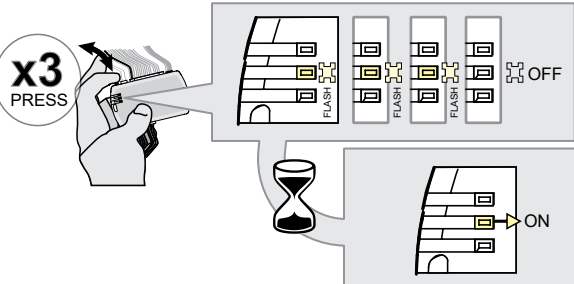

**Press and release** the programming button three (3x) times.

**Appuyez et relâchez** 3 fois le bouton de programmation.

↳ The **YELLOW** LED will flash 3 times each second.

↳ La **DEL JAUNE** clignote 3 fois chaque seconde.

↳ **WAIT** for the **YELLOW** LED to turn **ON** solide.

↳ **ATTENDRE** que la **DEL JAUNE** s'allume solide.

**5**

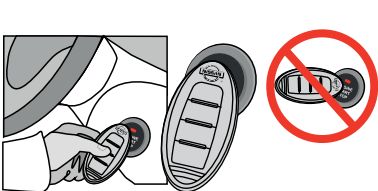

**Place** the OEM remote (no battery) close to the front of Start/Stop button Exactly as shown. Transponder is located behind the logo.

**Approchez** la télécommande d'origine (sans batterie) devant le bouton **START/STOP** exactement comme illustré. Le transpondeur de la télécommande se trouve derrière le logo.

FLASH RAPIDLY WAIT

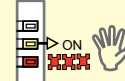

If the **RED** LED flash rapidly, wait until the LED turns **OFF**.

Si la **DEL ROUGE** clignote, attendre qu'elle s'éteigne.

**6**

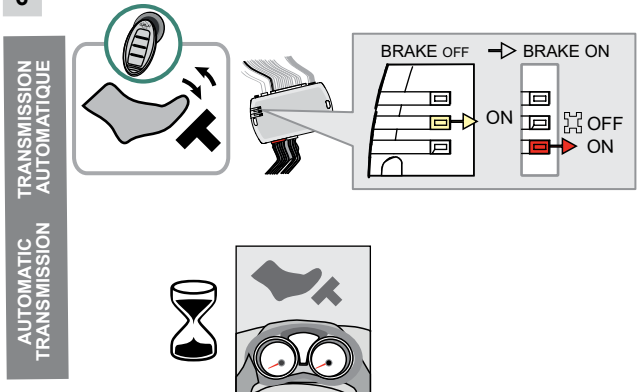

**Press and release** the foot-brake pedal.

**Appuyez et relâchez** la pédale de frein.

↳ The **RED** LED will turns **ON**.  
↳ The **YELLOW** LED turns **OFF**.

↳ La **DEL ROUGE** s'allume.  
↳ La **DEL JAUNE** s'éteint.

Wait until the message "press brake" disappears. (This may take up to 12 seconds).

Attendre que le message "press brake" disparaisse. (Cela peut prendre jusqu'à 12 secondes)

**KEY BYPASS PROGRAMMING PROCEDURE 2/2 | PROCÉDURE DE PROGRAMMATION CONTOURNEMENT DE CLÉ 2/2**

7

TRANSMISSION AUTOMATIQUE  
AUTOMATIC TRANSMISSION

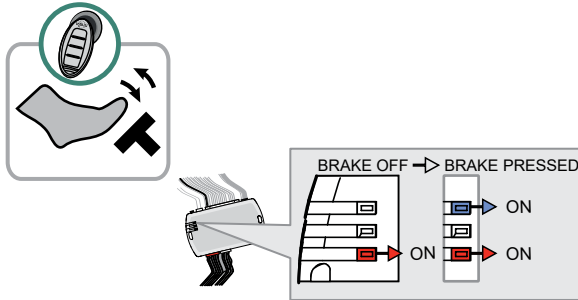

**Hold the OEM remote close to the front of START/STOP button**

**Tenir la télécommande d'origine devant le bouton START/STOP**

**Press and release the foot-brake pedal.**

**Appuyez et relâchez la pédale de frein.**

- ↳ The RED LED is ON.
- ↳ The BLUE LED turns ON.

- ↳ La DEL ROUGE est allumée.
- ↳ La DEL BLEU s'allume.

If the BLUE LED flash rapidly, wait until the LED turns OFF.

Si la DEL BLEU clignote, attendre qu'elle s'éteigne.

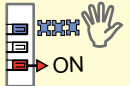

8

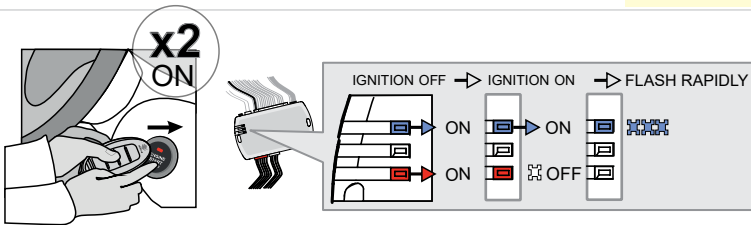

**Press the START/STOP button twice to turn ON the ignition.**

- ↳ The BLUE LED will Flash rapidly.
- ↳ The RED LED will turn OFF.

**Appuyez sur le bouton START/STOP 2 fois pour allumer l'ignition.**

- ↳ La DEL BLEU clignote rapidement.
- ↳ La DEL ROUGE s'éteint.

9

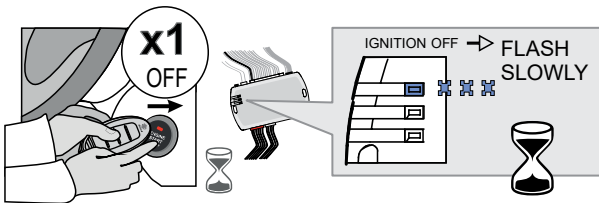

**Press the START/STOP button once to turn OFF the ignition.**  
↳ Wait until the BLUE LED flash slowly.

**Appuyez sur le bouton START/STOP 1 fois pour éteindre l'ignition.**  
↳ Attendez que la DEL BLEU clignote lentement.

10

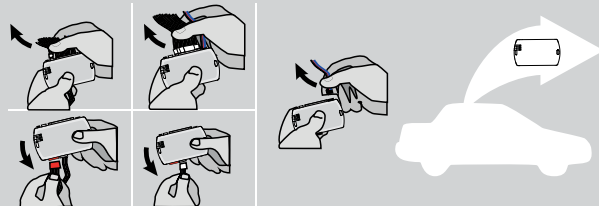

**Disconnect all the connectors and after the Data-Link (4-pins) connector.**

**Débranchez tous les connecteurs et ensuite le connecteur Data-Link (4-pins).**

11

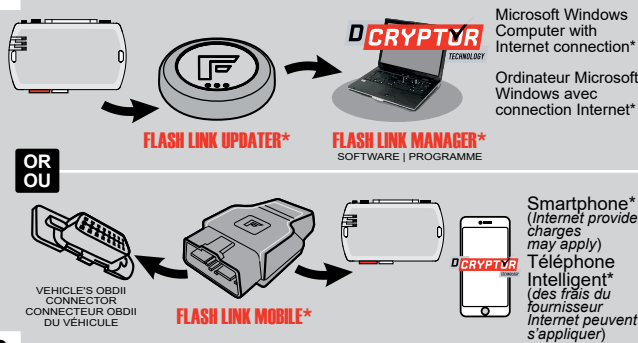

**Use the tool: FLASH LINK UPDATER or FLASH LINK MOBILE to visit the DCryptor menu.**

**Utilisez l'outil: FLASH LINK UPDATER ou FLASH LINK MOBILE pour visiter le menu DCryptor.**

\*Parts required (not included) \*Pièces requises (non incluses)

12

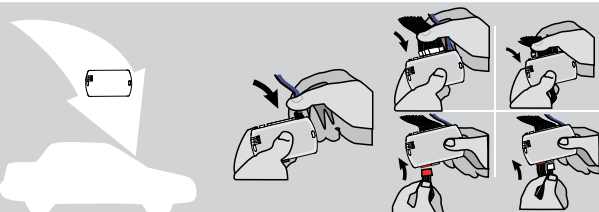

**AFTER DCRYPTOR PROGRAMMING COMPLETED Go back to the vehicle and reconnect the 4-Pin (Data-Link) connector and after, all the remaining connector.**

**APRÈS LA PROCÉDURE DE PROGRAMMATION DCRYPTOR COMPLÉTÉE : retournez au véhicule et rebranchez le connecteur 4-pins (Data-Link) et après, tous les connecteurs du EVO-ALL.**



The module is now programmed.  
Le module est programmé.



**REMOTE STARTER / ALARM VERIFICATION PROCEDURE | PROCÉDURE DE VÉRIFICATION DU DÉMARREUR À DISTANCE / ALARME**













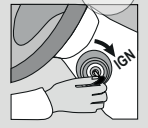
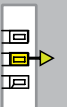

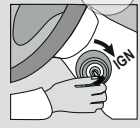
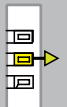
**Test the remote starter. Remote start the vehicle. Testez le démarreur à distance. Démarrez le véhicule à distance.**

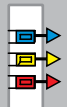
**OPTIONAL RF-KIT PROGRAMMING | PROGRAMMATION KIT RF OPTIONELLE**

**PROGRAM BYPASS OPTION | PROGRAMMATION DES OPTIONS DE CONTOURNEMENT**

	<p><b>Program bypass option:</b> Programmez l'option du contournement :</p>	<p><b>H2</b></p>	<p><input checked="" type="checkbox"/> Supported RF-KITS enable  <input checked="" type="checkbox"/> H2 Fortin 2  <input checked="" type="checkbox"/> Activation KITS RF supporté  <input checked="" type="checkbox"/> H2 Fortin 2</p>
---	---	------------------	--

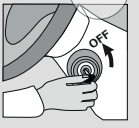



**OPTIONAL FORTIN RF KIT SERIES 4 OR SERIES 9 PROGRAMMING | PROGRAMMATION DU KIT RF FORITN SÉRIE 4 OU SÉRIE 9 (OPTIONNELLE)**

 <p>The module must be programmed on the vehicle.</p> <p>Le module doit être <b>programmé</b> sur le véhicule.</p>  <p><b>MAKE SURE THE IGNITION KEY HAS BEEN IN THE OFF POSITION FOR AT LEAST 5 SECONDS.</b></p> <p><b>ASSUREZ-VOUS QUE LA CLÉ DE CONTACT EST À LA POSITION OFF DEPUIS AU MOINS 5 SECONDES.</b></p>	<p><b>1</b></p> <p><b>ON</b> TURN ON/RUN</p>  <p>Turn the key to the ON/RUN position.</p> <p>Tournez la clé à la position ON/RUN.</p>  <p>The YELLOW LED will turn ON solid.</p> <p>La DEL JAUNE s'allumera solide.</p>	<p><b>2</b></p> <p><b>OFF</b> TURN OFF</p>  <p>Turn the ignition to the OFF position.</p> <p>Tournez la clé à la position ARRÊT (OFF).</p>  <p>The YELLOW LED will turn Off.</p> <p>La DEL JAUNE s'éteindra.</p>	<p><b>3</b></p> <p><b>ON</b> TURN ON/RUN</p>  <p>Turn the key to the ON/RUN position.</p> <p>Tournez la clé à la position ON/RUN.</p>  <p>The YELLOW LED will turn ON solid.</p> <p>La DEL JAUNE s'allumera solide.</p>	<p><b>4</b></p> <p><b>4X BRAKES</b></p> <p>x4 PRESS</p>  <p>Press and release the brake pedal four times.</p> <p>Appuyez et relâchez quatre fois la pédale de frein.</p>  <p>The LED will flash rapidly.</p> <p>Le témoin clignotera rapidement.</p>  <p>The 3 LED will turn ON solid.</p> <p>Les 3 DELs s'allumeront solide.</p>	<p><b>5</b></p> <p>ON EACH TRANSMITTER SUR CHACUNE DES TÉLÉCOMMANDES</p> <p><b>4 BUTTONS 4 BOUTONS</b></p>  <p>PRESS AND RELEASE APPUYEZ ET RELÂCHEZ</p>  <p>PRESS AND RELEASE APPUYEZ ET RELÂCHEZ</p>  <p>PRESS AND RELEASE APPUYEZ ET RELÂCHEZ</p> <p><b>1 BUTTON 1 BOUTON</b></p> <p>PRESS APPROX. 12 SEC. AND WAIT FOR THE BLUE LED TO TURN OFF THEN BACK ON SOLID THEN RELEASE.</p> <p>APPUYEZ ET TENEZ ENFONCÉ LE POUR APPROX. 12 SEC. LA DEL BLEUE S'ÉTEINT ET S'ALLUME SOLIDE, ENSUITE RELÂCHEZ.</p>  <p>The LED will turn off each time.</p> <p>Le témoin s'éteindra chaque fois.</p>  <p>The LED will flash rapidly.</p> <p>Le témoin clignotera rapidement.</p>  <p>The 3 LED will turn off each time.</p> <p>Les 3 DELs s'éteindront chaque fois.</p>	<p><b>6</b></p> <p><b>OFF</b> TURN OFF</p>  <p>Turn the ignition to the OFF position.</p> <p>Tournez la clé à la position ARRÊT (OFF).</p>  <p>The LED will turn Off.</p> <p>Le témoin s'éteint</p>  <p>The 3 LED will turn off.</p> <p>Les 3 DELs s'éteindront.</p>
---	---	--	---	---	---	---



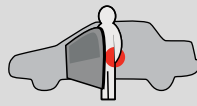

REMOTE STARTER FUNCTIONALITY | FONCTIONNALITÉS DU DÉMARREUR À DISTANCE

				
<p>All doors must be closed.</p>	<p><b>Remote start</b> the vehicle.</p>	<p><b>Unlock</b> the doors with either:</p> <ul style="list-style-type: none"> <li>• The OEM remote</li> <li>• The remote-starter remote</li> <li>• Or the proximity remote</li> </ul>	<p><b>Enter</b> the vehicle with the Intelligent Key.</p>	<p>The vehicle can now be put in to gear and driven.</p>
<p>Toutes les portes doivent être fermées</p>	<p><b>Démarrez</b> à distance.</p>	<p><b>Déverrouillez</b> les portes avec soit:</p> <ul style="list-style-type: none"> <li>• la télécommande d'origine</li> <li>• la télécommande du démarreur à distance</li> <li>• ou la télécommande de proximité.</li> </ul>	<p><b>Entrez</b> dans le véhicule avec la clé intelligente sur vous</p>	<p>Vous êtes maintenant prêt à embrayer et prendre la route.</p>

If the vehicle is not unlocked with one of these conditions the remote-starter will shut down as soon as any door is opened.  
Si le véhicule n'est pas déverrouillé avec l'une de ces conditions, à l'ouverture de l'une des portes, le module va éteindre le démarreur à distance et le véhicule.





Module label | Étiquette sur le module

### Notice: Updated Firmware and Installation Guides

Updated firmware and installation guides are posted on our web site on a regular basis. We recommend that you update this module to the latest firmware and download the latest installation guide(s) prior to the installation of this product.

### Notice: Mise à jour microprogramme et Guides d'installations

Des mises à jour du Firmware (microprogramme) et des guides d'installation sont mis en ligne régulièrement. Vérifiez que vous avez bien la dernière version logiciel et le dernier guide d'installation avant l'installation de ce produit.

## WARNING

The information on this sheet is provided on an (as is) basis with no representation or warranty of accuracy whatsoever. It is the sole responsibility of the installer to check and verify any circuit before connecting to it. Only a computer safe logic probe or digital multimeter should be used. FORTIN ELECTRONIC SYSTEMS assumes absolutely no liability or responsibility whatsoever pertaining to the accuracy or currency of the information supplied. The installation in every case is the sole responsibility of the installer performing the work and FORTIN ELECTRONIC SYSTEMS assumes no liability or responsibility whatsoever resulting from any type of installation, whether performed properly, improperly or any other way. Neither the manufacturer or distributor of this module is responsible of damages of any kind indirectly or directly caused by this module, except for the replacement of this module in case of manufacturing defects. This module must be installed by qualified technician. The information supplied is a guide only. This instruction guide may change without notice. Visit [www.fortinbypass.com](http://www.fortinbypass.com) to get the latest version.

## MISE EN GARDE

L'information de ce guide est fournie sur la base de représentation (telle quelle) sans aucune garantie de précision et d'exactitude. Il est de la seule responsabilité de l'installateur de vérifier tous les fils et circuits avant d'effectuer les connexions. Seuls une sonde logique ou un multimètre digital doivent être utilisés. FORTIN SYSTÈMES ÉLECTRONIQUES n'assume aucune responsabilité de l'exactitude de l'information fournie. L'installation (dans chaque cas) est la responsabilité de l'installateur effectuant le travail. FORTIN SYSTÈMES ÉLECTRONIQUES n'assume aucune responsabilité suite à l'installation, que celle-ci soit bonne, mauvaise ou de n'importe autre type. Ni le manufacturier, ni le distributeur ne se considèrent responsables des dommages causés ou ayant pu être causés, indirectement ou directement, par ce module, excepté le remplacement de ce module en cas de défectuosité de fabrication. Ce module doit être installé par un technicien qualifié. L'information fournie dans ce guide est une suggestion. Ce guide d'instruction peut faire l'objet de changement sans préavis. Consultez le [www.fortinbypass.com](http://www.fortinbypass.com) pour voir la plus récente version.

Copyright © 2006-2018, FORTIN AUTO RADIO INC ALL RIGHTS RESERVED PATENT PENDING



## TECH SUPPORT

Tél: 514-255-HELP (4357)  
1-877-336-7797



## ADDENDUM GUIDE

[www.fortinbypass.com](http://www.fortinbypass.com)

WEB UPDATE | MISE À JOUR INTERNET

