

THAR-GM6 THARNESSE INSTALLATION INSTALLATION HARNAIS THAR-GM6

 ADDENDUM - SUGGESTED WIRING CONFIGURATION
 ADDENDA - SCHÉMA DE BRANCHEMENT SUGGÉRÉ

VEHICLE VEHICULES	YEARS ANNÉES	Vehicle functions supported in this diagram (functional if equipped) Fonctions du véhicule supportées dans ce diagramme (fonctionnelles si équipé)													
		Immobilizer bypass Contournement d'immobilisateur	Lock	Unlock	Arm	Disarm	Trunk (open)	RAP Disable	Tachometer	Heated Seats	Door Status	Trunk Status	Hand-Brake Status	Foot-Brake Status	OEM Remote Monitoring
 CHEVROLET Cruze	2016-2019 <i>Push-To-Start</i>	•	•	•	•	•	•	•	•	•	•	•	•	•	•



**BYPASS FIRMWARE VERSION
VERSION LOGICIELLE CONTOURNEMENT**

70.[45]

MINIMUM

To add the firmware version and the options, use the **FLASH LINK UPDATER** or **FLASH LINK MOBILE** tool, sold separately.

Pour ajouter la version logicielle et les options, utilisez l'outil **FLASH LINK UPDATER** ou **FLASH LINK MOBILE**, vendu séparément.

	UNIT OPTION OPTION UNITE	DESCRIPTION
 <p style="text-align: center;">Program bypass option: Programmez l'option du contournement:</p>	C1	OEM Remote status (Lock/Unlock) monitoring Suivi des status (Verrouillage/Déverrouillage) de la télécommande d'origine

IF THE VEHICLE IS NOT EQUIPPED WITH FUNCTIONAL HOOD PIN: SI LE VÉHICULE N'EST PAS ÉQUIPÉ D'UN CONTACT DE CAPOT FONCTIONNEL:	A11	OFF NON	Hood trigger (Output Status). Contact de capot (état de sortie).
--	------------	------------	---

	D6		Push-to-Start Push-to-Start
--	-----------	--	--------------------------------



ATTENTION!



DATE: XX-XX

E5	OFF NON	By default DEACTIVATED Par défaut DÉSACTIVÉ
	ON OUI	MANUFACTURED MODULES BETWEEN: 04/2018 TO 04/2019 MODULES MANUFACTURÉS ENTRE: 04/2018 AU 04/2019

Parts required (Not included): 1X THAR-GM6 **Pièce(s) requise(s) (Non incluse(s)): 1X THAR-GM6**

MANDATORY INSTALL | INSTALLATION OBLIGATOIRE

*** HOOD PIN CONTACT DE CAPOT**

HOOD STATUS: THE HOOD PIN SWITCH (INCLUDED) MUST BE INSTALLED IF THE VEHICLE CAN BE REMOTE STARTED WITH THE HOOD OPEN, SET FUNCTION **A11** TO OFF.
STATUT DE CAPOT: LE CONTACT DE CAPOT (INCLUS), DOIT ÊTRE INSTALLÉ SI LE VÉHICULE PEUT DÉMARRER À DISTANCE, LORSQUE LE CAPOT EST OUVERT, PROGRAMMEZ LA FONCTION **A11** À NON.

SECURITY STICKER AUTOCOLLANT DE SÉCURITÉ



Notice: the installation of safety elements are mandatory. The hood pin and the sticker are essential security elements and must be installed.
Notice: l'installation des éléments de sécurité est obligatoire. Le contact de capot et l'autocollant de sécurité sont des éléments de sécurité essentiels et doivent absolument être installés.

THIS MODULE MUST BE INSTALLED BY A QUALIFIED TECHNICIAN. A WRONG CONNECTION CAN CAUSE PERMANENT DAMAGE TO THE VEHICLE.

CE MODULE DOIT ÊTRE INSTALLÉ PAR UN TECHNICIEN QUALIFIÉ, TOUTE ERREUR DANS LES BRANCHEMENTS PEUT OCCASIONNER DES DOMMAGES PERMANENTS AU VÉHICULE.

DESCRIPTION | DESCRIPTION

**Program remote starter option for R.S.
OEM REMOTE STAND ALONE:
Programmez l'option démarreur à distance pour TÉLÉCOMMANDE
D'ORIGINE STAND ALONE:**

38

2

Enable
Press 3x Lock to remote start with the OEM remote.
Activé Appuyez x3 sur Verrouille de la télécommande d'origine pour démarrer à distance le véhicule.



BCM, Above Driver kick panel
BCM, Au-dessus du panneau latéral côté conducteur

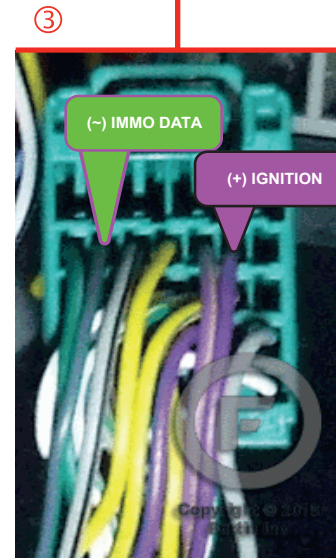
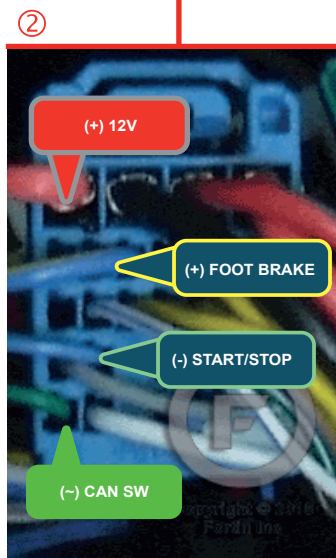
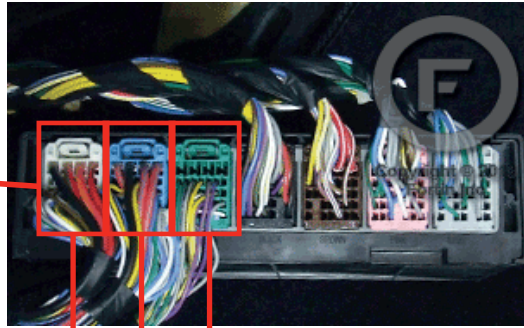

AUTOMATIC TRANSMISSION WIRING CONNECTION | SCHÉMA DE BRANCHEMENT TRANSMISSION AUTOMATIQUE

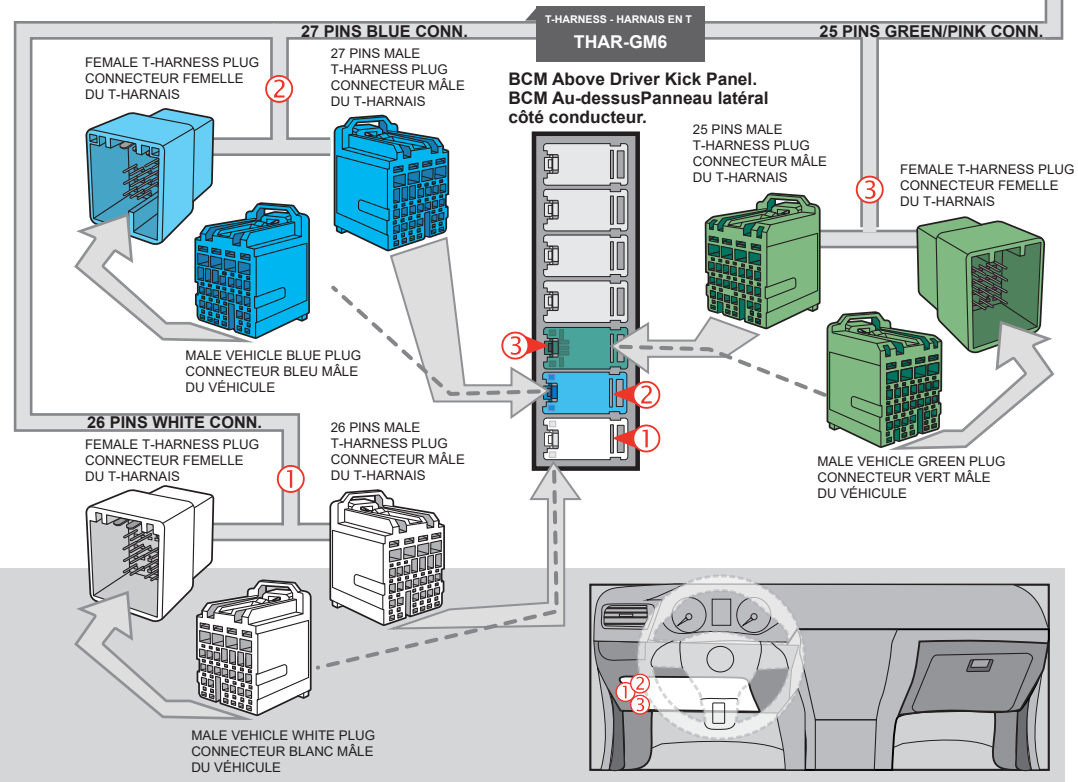
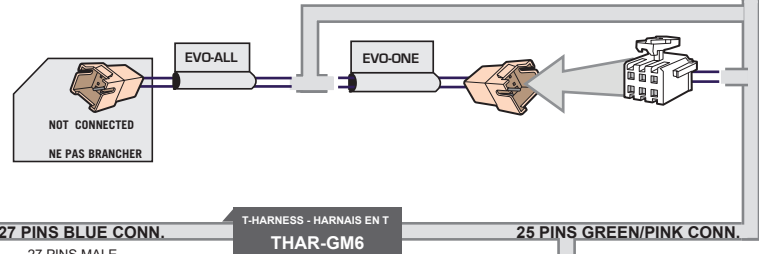
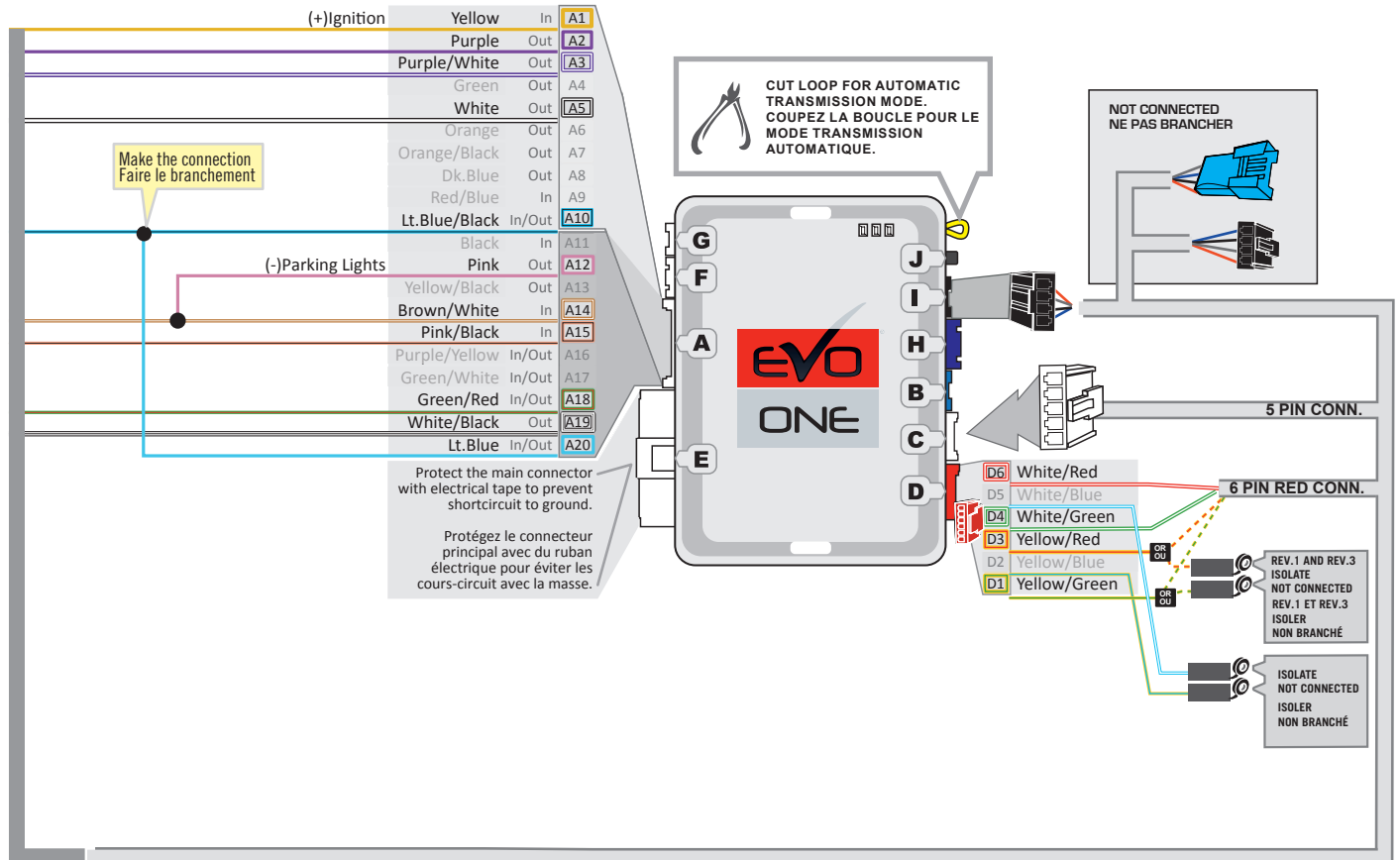

KEY BYPASS PROGRAMMING PROCEDURE 1/2 | PROCÉDURE DE PROGRAMMATION CONTOURNEMENT DE CLÉ 1/2

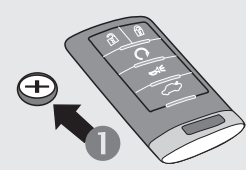
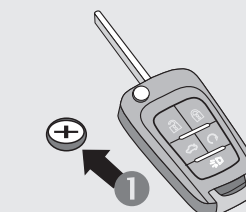
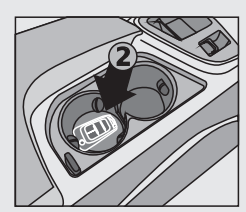
FIRST GENERATION PREMIÈRE GÉNÉRATION	 <p>1 Remove the battery from the OEM remote.</p> <p>2 First generation OEM remotes: Place the OEM remotes in the key older.</p>	<p>1 Retirez la batterie de la télécommande d'origine.</p> <p>2 1^{ère} génération de clé: Placez la télécommandes d'origine du véhicule dans le compartiment de la clé.</p>	
SECOND GENERATION SECONDE GÉNÉRATION	 <p>1 Remove the battery from the OEM remote.</p> <p>2 Second generation OEM remotes: Place the OEM remotes in to the center console.</p>	<p>1 Retirez la batterie de la télécommande d'origine.</p> <p>2 2^{ème} génération de clé: Placez la télécommandes d'origine du véhicule dans la console centrale.</p>	

1

 <p>x1 HOLD</p>	<p>Press and hold the programming button: Insert the 6-Pin Main connector.</p> <p><i>↳ The LEDs will alternate between BLUE, RED, YELLOW & BLUE/RED flashes.</i></p>	<p>Appuyez et maintenir le bouton de programmation enfoncé: Insérez le connecteur Principal à 6-broches.</p> <p><i>↳ Les DELS alterneront entre un clignotement BLEU, ROUGE, JAUNE & BLEU/ROUGE.</i></p>
---	---	---

2

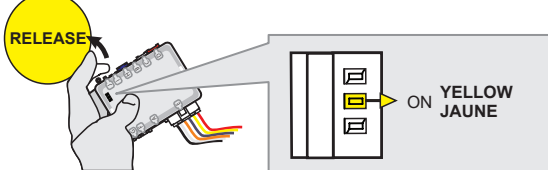
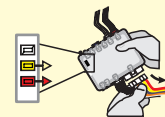
 <p>RELEASE</p>	<p>Release the programming button when the LED is YELLOW.</p> <p><i>If the LED is not solid YELLOW disconnect the 6-Pin connector (Main-Harness) and go back to step 1.</i></p>	<p>Relâchez le bouton de programmation quand la DEL est JAUNE.</p> <p><i>Si le DEL n'est pas JAUNE débranchez le connecteur 6 pins (Connecteur principal et allez au début de l'étape 1.</i></p> 
--	--	--

3

	<p>Insert the required remaining connectors.</p>	<p>Insérez les connecteurs requis restants.</p>
---	---	--

4

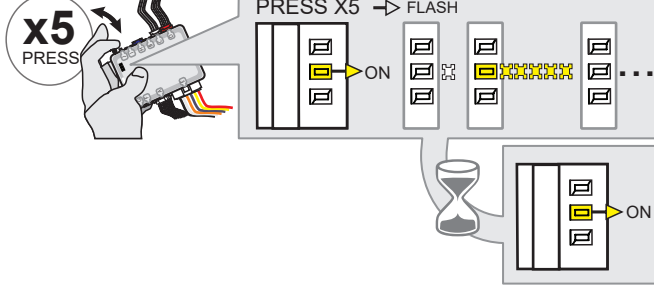
 <p>x5 PRESS</p> <p>PRESS X5 → FLASH</p> <p>WAIT</p>	<p>Press and release the programming button five (5x) times.</p> <p><i>↳ The YELLOW LED will flash 5 times each second.</i></p> <p>WAIT</p> <p><i>↳ WAIT for the YELLOW LED to turn ON solide.</i></p>	<p>Appuyez et relâchez 5 fois le bouton de programmation.</p> <p><i>↳ La DEL JAUNE clignote 5 fois chaque seconde.</i></p> <p>ATTENDRE</p> <p><i>↳ ATTENDRE que la DEL JAUNE s'allume solide.</i></p>
--	--	---

5

	<p>Open the driver door.</p>	<p>Ouvrez la porte conducteur.</p>
---	-------------------------------------	---

6

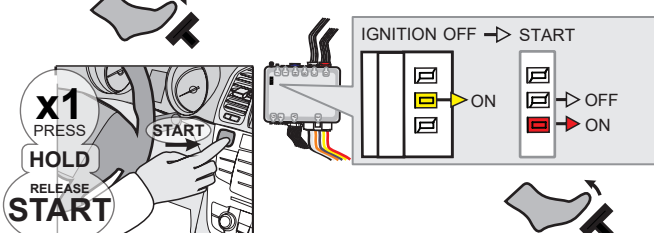
 <p>x1 PRESS</p> <p>HOLD START</p> <p>RELEASE START</p>	<p>Press the foot-brake pedal.</p> <p>Press the Push-to-Start button until the engine start.</p> <p>Release the foot-brake pedal.</p> <p><i>↳ The RED LED will turn ON.</i></p> <p><i>↳ The YELLOW LED will turn OFF.</i></p>	<p>Appuyez la pédale de frein.</p> <p>Appuyez sur le bouton démarrage jusqu'à se que le moteur démarre.</p> <p>Relâchez la pédale de frein.</p> <p><i>↳ La DEL ROUGE s'allume.</i></p> <p><i>↳ La DEL JAUNE s'éteint.</i></p>
---	--	--

KEY BYPASS PROGRAMMING PROCEDURE 2/2 | PROCÉDURE DE PROGRAMMATION CONTOURNEMENT DE CLÉ 2/2

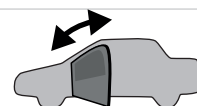
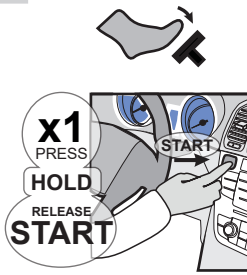
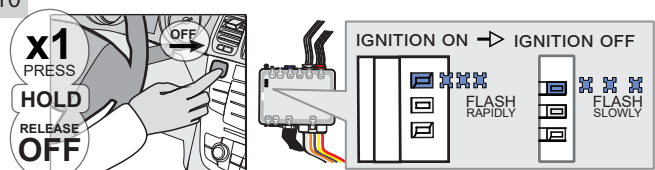
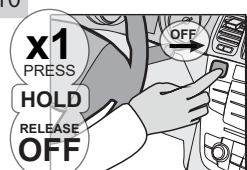
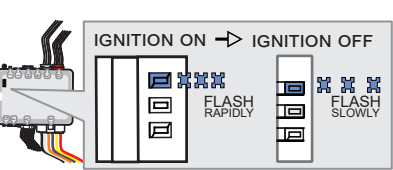
<p>7</p> 	<p>Press the Push-to-Start button until the engine turn OFF.</p>	<p>Appuyez sur le bouton démarrage jusqu'à se que le moteur s'éteigne.</p>
<p>8</p> 	<p>Close and open the driver door.</p>	<p>Fermez et ouvrez la porte conducteur.</p>
<p>9</p> 	<p>Press the foot-brake pedal.</p>	<p>Appuyez la pédale de frein.</p>
	<p>Press the Push-to-Start button until the engine start.</p>	<p>Appuyez sur le bouton démarrage jusqu'à se que le moteur démarre.</p>
	<p>Release the foot-brake pedal.</p>	<p>Relâchez la pédale de frein.</p>
	<p>↳ The BLUE LED will turn ON.</p>	<p>↳ La DEL BLEU s'allume.</p>
	<p>↳ The BLUE LED will turn OFF. The RED LED will turn OFF.</p>	<p>↳ La DEL BLEU s'éteint. La DEL ROUGE s'éteint.</p>
	<p>↳ The YELLOW LED will flash rapidly</p>	<p>↳ La DEL JAUNE clignote rapidement.</p>
	<p>↳ The BLUE LED will turn ON.</p>	<p>↳ La DEL BLEU s'allume.</p>
	<p>↳ The BLUE LED will flash rapidly</p>	<p>↳ La DEL BLEU clignote rapidement.</p>
<p>10</p> 	<p>Press the Push-to-Start button until the engine turn OFF.</p>	<p>Appuyez sur le bouton démarrage jusqu'à se que le moteur s'éteigne.</p>
	<p>↳ The BLUE LED will flash slowly</p>	<p>↳ La DEL BLEU clignote lentement.</p>
<p>11</p> 	<p>Disconnect all connectors and after the 6-Pin (Main-Harness) or the 4-Pin Data-link connector.</p>	<p>Débranchez tous les connecteurs et ensuite le connecteur 6-pins (Connecteur principal) ou le connecteur 4-pins (Data-Link).</p>
<p>12</p> 	<p>Microsoft Windows Computer with Internet connection*</p>	<p>Ordinateur Microsoft Windows avec connection Internet*</p>
	<p>Use the tool: FLASH LINK UPDATER or FLASH LINK MOBILE to visit the DCryptor menu.</p>	<p>Utilisez l'outil: FLASH LINK UPDATER ou FLASH LINK MOBILE pour visiter le menu DCryptor.</p>
	<p>*Parts required (not included) *Pièces requises (non incluses)</p>	

KEY BYPASS PROGRAMMING PROCEDURE 3/3 | PROCÉDURE DE PROGRAMMATION CONTOURNEMENT DE CLÉ 3/3

13

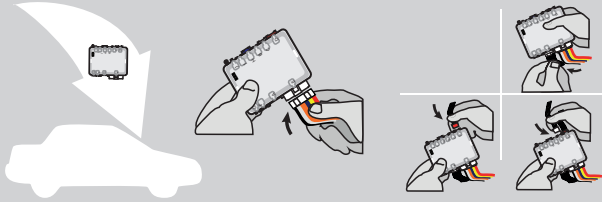

AFTER DCRYPTOR PROGRAMMING COMPLETED
Go back to the vehicle and **reconnect** the 6-Pin (Main-Harness) or the 4-pins (Data-Link) connector and after all the remaining connector.

APRÈS LA PROCÉDURE DE PROGRAMMATION DCRYPTOR COMPLÉTÉE : retournez au véhicule et **rebranchez** le connecteur 6-pins (Connecteur principal) ou le 4-pins (Data-Link) et après tous les connecteurs.



*The module is now programmed.
Le module est programmé.*



REMOTE STARTER / ALARM VERIFICATION PROCEDURE | PROCÉDURE DE VÉRIFICATION DU DÉMARREUR À DISTANCE / ALARME

Test the remote starter. Remote start the vehicle.
Testez le démarreur à distance. Démarrez le véhicule à distance.

REMOTE STARTER PROGRAMMING PROCEDURE | PROCÉDURE DE PROGRAMMATION DU DÉMARREUR À DISTANCE

 REFER TO THE **QUICK INSTALL GUIDE** INCLUDED WITH THE MODULE FOR THE REMOTE STARTER PROGRAMMING.

 RÉFÉREZ-VOUS AU **GUIDE D'INSTALLATION RAPIDE** INCLUS AVEC LE MODULE POUR LA PROGRAMMATION DU DÉMARREUR À DISTANCE.



REMOTE STARTER FUNCTIONALITY | FONCTIONNALITÉS DU DÉMARREUR À DISTANCE



All doors must be closed.

Toutes les portes doivent être fermées

Remote start the vehicle.

Démarrez à distance.



Press the Unlock button of the remote car starter.

Appuyez sur le bouton Déverrouillage de la télécommande du démarreur à distance.



Enter the vehicle with the Intelligent Access Key.

Entrez dans le véhicule avec la clé intelligente (Access Key) sur vous



The vehicle can now be put in to gear and driven.

Vous êtes maintenant prêt à embrayer et prendre la route.



If the vehicle is not unlocked the module will shut down the remote-starter and the vehicle as soon as any door is opened.
Si le véhicule n'est pas déverrouillé le module va éteindre le démarreur à distance et le véhicule à l'ouverture de l'une des portes.



Module label | Étiquette sur le module

Notice: Updated Firmware and Installation Guides

Updated firmware and installation guides are posted on our web site on a regular basis. We recommend that you update this module to the latest firmware and download the latest installation guide(s) prior to the installation of this product.

Notice: Mise à jour microprogramme et Guides d'installations

Des mises à jour du Firmware (microprogramme) et des guides d'installation sont mis en ligne régulièrement. Vérifiez que vous avez bien la dernière version logiciel et le dernier guide d'installation avant l'installation de ce produit.

WARNING

The information on this sheet is provided on an (as is) basis with no representation or warranty of accuracy whatsoever. It is the sole responsibility of the installer to check and verify any circuit before connecting to it. Only a computer safe logic probe or digital multimeter should be used. FORTIN ELECTRONIC SYSTEMS assumes absolutely no liability or responsibility whatsoever pertaining to the accuracy or currency of the information supplied. The installation in every case is the sole responsibility of the installer performing the work and FORTIN ELECTRONIC SYSTEMS assumes no liability or responsibility whatsoever resulting from any type of installation, whether performed properly, improperly or any other way. Neither the manufacturer or distributor of this module is responsible of damages of any kind indirectly or directly caused by this module, except for the replacement of this module in case of manufacturing defects. This module must be installed by qualified technician. The information supplied is a guide only. This instruction guide may change without notice. Visit www.fortinbypass.com to get the latest version.

MISE EN GARDE

L'information de ce guide est fournie sur la base de représentation (telle quelle) sans aucune garantie de précision et d'exactitude. Il est de la seule responsabilité de l'installateur de vérifier tous les fils et circuits avant d'effectuer les connexions. Seuls une sonde logique ou un multimètre digital doivent être utilisés. FORTIN SYSTÈMES ÉLECTRONIQUES n'assume aucune responsabilité de l'exactitude de l'information fournie. L'installation (dans chaque cas) est la responsabilité de l'installateur effectuant le travail. FORTIN SYSTÈMES ÉLECTRONIQUES n'assume aucune responsabilité suite à l'installation, que celle-ci soit bonne, mauvaise ou de n'importe autre type. Ni le fabricant, ni le distributeur ne se considèrent responsables des dommages causés ou ayant pu être causés, indirectement ou directement, par ce module, excepté le remplacement de ce module en cas de défectuosité de fabrication. Ce module doit être installé par un technicien qualifié. L'information fournie dans ce guide est une suggestion. Ce guide d'instruction peut faire l'objet de changement sans préavis. Consultez le www.fortinbypass.com pour voir la plus récente version.

Copyright © 2006-2018, FORTIN AUTO RADIO INC ALL RIGHTS RESERVED PATENT PENDING



TECH SUPPORT

Tél: 514-255-HELP (4357)
1-877-336-7797



ADDENDUM GUIDE

www.fortinbypass.com

WEB UPDATE | MISE À JOUR INTERNET

