

**REGULAR INSTALLATION  
INSTALLATION RÉGULIÈRE**

 ADDENDUM - SUGGESTED WIRING CONFIGURATION  
 ADDENDA - SCHÉMA DE BRANCHEMENT SUGGÉRÉ

VEHICLE VEHICULES	YEARS ANNÉES	CONFIGURATIONS		Vehicle functions supported in this diagram (functional if equipped)   Fonctions du véhicule supportées dans ce diagramme (fonctionnelles si équipé)						
		Without doorlocks Sans verrouillage des portes	With doorlocks INT-SL+ required Avec verrouillage des portes INT-SL+ requis	Immobilizer bypass Contournement d'immobilisateur	Lock	Unlock	Arm	Disarm	Trunk (open)	Parking Lights
<b>LEXUS</b> RX 400H	Key 2006-2009	1	2	•	•	•	•	•	•	•

To control the door lock a **INT-SL+\*** module must be use. (\*Sold separately)  
 Pour le contrôle des portes un **INT-SL+** doit être installé. (\*Vendu séparément)



**BYPASS FIRMWARE VERSION  
VERSION LOGICIELLE CONTOURNEMENT**

**79.[65]**

TOYOTA/LEXUS/SUBARU MINIMUM

To add the firmware version and the options, use the **FLASH LINK UPDATER** or **FLASH LINK MOBILE** tool, sold separately.  
 Pour ajouter la version logicielle et les options, utilisez l'outil **FLASH LINK UPDATER** ou **FLASH LINK MOBILE**, vendu séparément.





FIRMWARE VERSION  
VERSION DU LOGICIEL

**V0.17**

**INT-SL+**

<b>IF THE VEHICLE IS NOT EQUIPPED WITH FUNCTIONAL HOOD PIN: SI LE VÉHICULE N'EST PAS ÉQUIPÉ D'UN CONTACT DE CAPOT FONCTIONNEL:</b>	<b>A11</b>	<b>OFF NON</b>	Hood trigger (Output Status). Contact de capot (état de sortie).
--	------------	--------------------	---

	<b>Program bypass option (Vehicle hybrid only): Programmez l'option du contournement (véhicule hybride seulement):</b>	<b>D4</b>	<table border="1"> <thead> <tr> <th>UNIT OPTION OPTION UNITE</th> <th>DESCRIPTION</th> </tr> </thead> <tbody> <tr> <td>Hybrid mode (Vehicle hybrid only)</td> <td>Mode hybride (véhicule hybride seulement)</td> </tr> </tbody> </table>	UNIT OPTION OPTION UNITE	DESCRIPTION	Hybrid mode (Vehicle hybrid only)	Mode hybride (véhicule hybride seulement)
	UNIT OPTION OPTION UNITE	DESCRIPTION					
Hybrid mode (Vehicle hybrid only)	Mode hybride (véhicule hybride seulement)						

	FUNCTION FONCTION	MODE	DESCRIPTION
 <p><b>Program remote starter option: Programmez l'option du démarreur à distance:</b></p>	<b>20</b>	<b>5</b>	Start (crank) 8 seconds et supervision par Tach en Data-Link. Démarrage (crank) 8 secondes & supervision by Tach in Data-Link.
	<b>32</b>	<b>3</b>	DK.Blue (GWR) Shut Down After BleuFoncé (Masse d'activation) Sortie après l'arrêt.

 <p><b>Parts required (Not included)</b></p> <p>1x 10 Amp fuse max. 1x Optional INT-SL+ for door locks</p>	<p><b>Pièce(s) requise(s) (Non include(s))</b></p> <p>1x fusible 10 Amp max. 1x INT-SL+ Optionnel pour verrouillage des portes</p>
---	--

<p><b>MANDATORY INSTALL   INSTALLATION OBLIGATOIRE</b></p> <p><b>* HOOD PIN CONTACT DE CAPOT</b></p> <p> <b>HOOD STATUS:</b> THE HOOD PIN SWITCH (INCLUDED) MUST BE INSTALLED IF THE VEHICLE CAN BE REMOTE STARTED WITH THE HOOD OPEN, SET FUNCTION <b>A11</b> TO OFF.  <b>STATUT DE CAPOT:</b> LE CONTACT DE CAPOT (INCLUS), DOIT ÊTRE INSTALLÉ SI LE VÉHICULE PEUT DÉMARRER À DISTANCE, LORSQUE LE CAPOT EST OUVERT, PROGRAMMEZ LA FONCTION <b>A11</b> À NON.</p>	<p><b>A11</b></p> <p style="background-color: red; color: white; padding: 2px;"><b>OFF NON</b></p>	<p><b>SECURITY STICKER AUTOCOLLANT DE SÉCURITÉ</b></p> <p> Included Inclus</p>	<p><b>Notice:</b> the installation of safety elements are mandatory. The hood pin and the sticker are essential security elements and must be installed.  <b>Notice:</b> l'installation des éléments de sécurité est obligatoire. Le contact de capot et l'autocollant de sécurité sont des éléments de sécurité essentiels et doivent absolument être installés.</p> <p>THIS MODULE MUST BE INSTALLED BY A QUALIFIED TECHNICIAN. A WRONG CONNECTION CAN CAUSE PERMANENT DAMAGE TO THE VEHICLE.                  CE MODULE DOIT ÊTRE INSTALLÉ PAR UN TECHNICIEN QUALIFIÉ, TOUTE ERREUR DANS LES BRANCHEMENTS PEUT OCCASIONNER DES DOMMAGES PERMANENTS AU VÉHICULE.</p>
--	--	---	--

DESCRIPTION | DESCRIPTION

② At Transponder connector  
Au connecteur du transpondeur

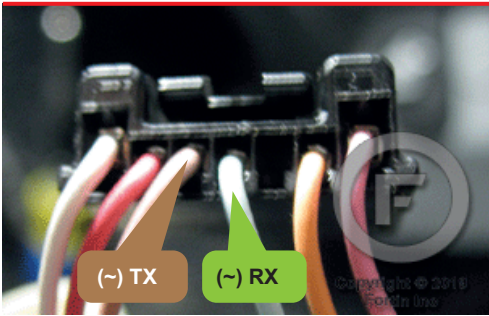

① At Ignition harness  
Au harnais d'ignition

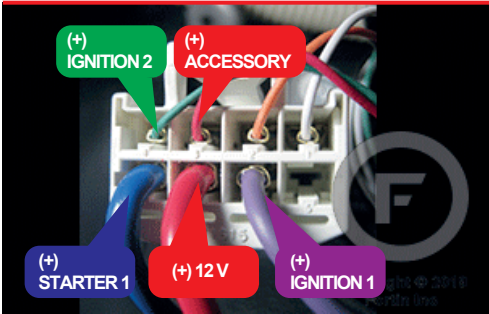

⑤ Driver kick panel  
Panneau latérale conducteur

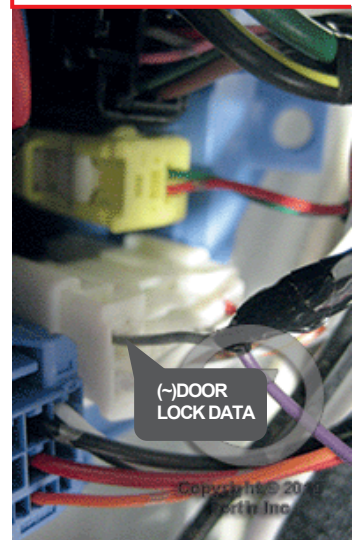

⑦ At Module under Fuse Box  
Au module sous la boîte à fusibles

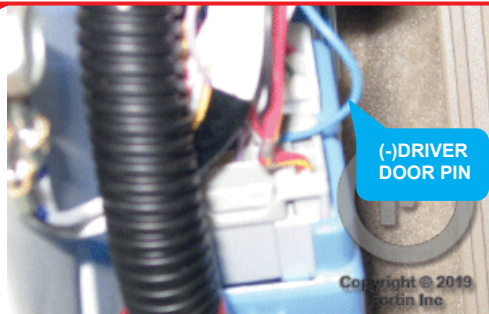
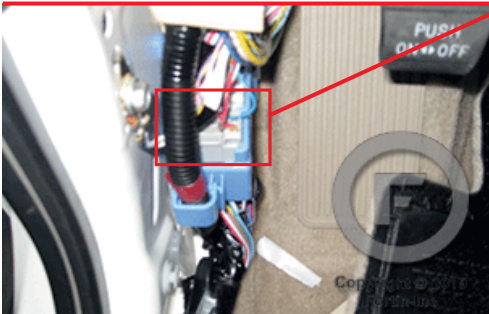

**CONFIG.1 AUTOMATIC TRANSMISSION WIRING CONNECTION | GUIDE DE BRANCHEMENTS TRANSMISSION AUTOMATIQUE**

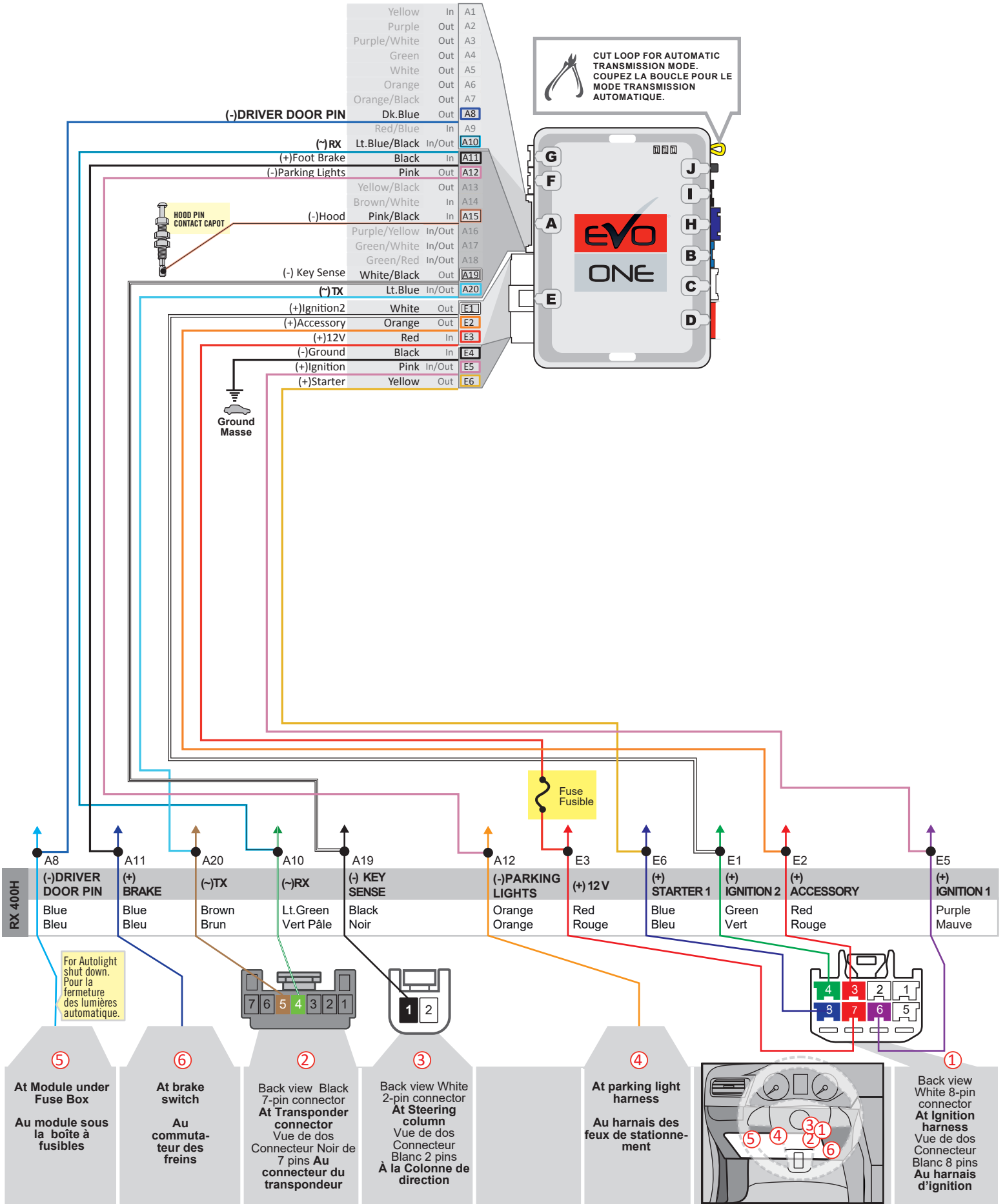

**CONFIG.2 AUTOMATIC TRANSMISSION WIRING CONNECTION | GUIDE DE BRANCHEMENTS TRANSMISSION AUTOMATIQUE**

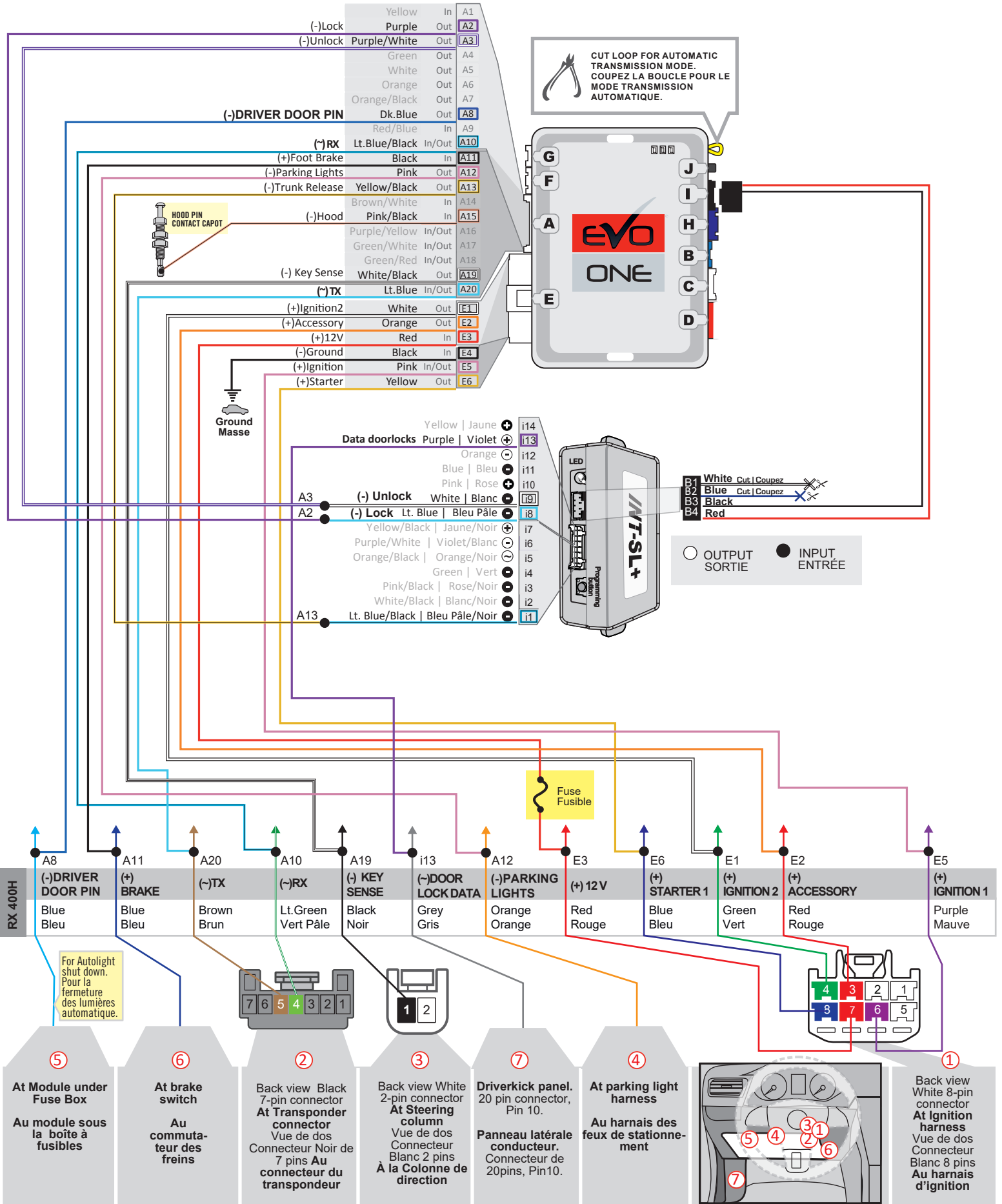

**KEY BYPASS PROGRAMMING PROCEDURE | PROCÉDURE DE PROGRAMMATION CONTOURNEMENT DE CLÉ**

1

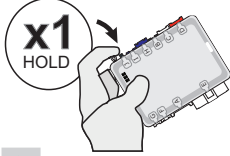

**Press and hold the programming button.**

**Appuyez et maintenir enfoncé le bouton de programmation.**

2

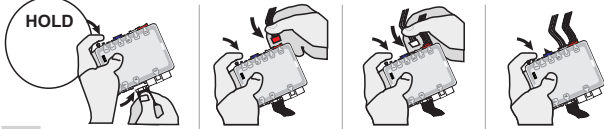

**Insert the connectors:**  
20 pin (White),  
6 pin (Red),  
5 pin (White),  
2 pin (White).  
(If required)

**Insérez les connecteurs:**  
20 pins (Blanc),  
6 pins (Rouge),  
5 pins (Blanc),  
2 pins (Blanc).  
(Si requis)

3

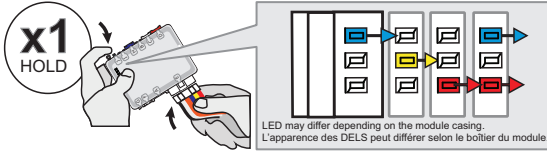

**Insert the 6-Pin Main connector.**

**Insérez le connecteur Principal à 6-broches.**

↳The LEDs will alternate between BLUE, RED, YELLOW & BLUE/RED flashes.

↳Les DELS alterneront entre un clignotement BLEU, ROUGE, JAUNE & BLEU/ROUGE.

4

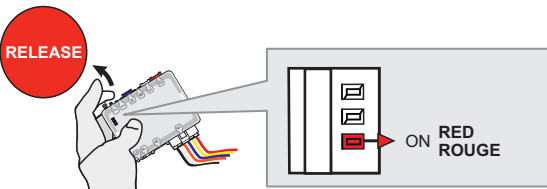

**Release the programming button when the LED is RED.**

**Relâchez le bouton de programmation quand la DEL est ROUGE.**

*If the LED is not solid RED disconnect the 6 Pin connector (Main-Harness) and go back to step 1.*

*Si le DEL n'est pas ROUGE solide débranchez le connecteur 6 pins (Connecteur principal) et allez à l'étape 1.*

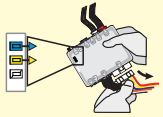

5

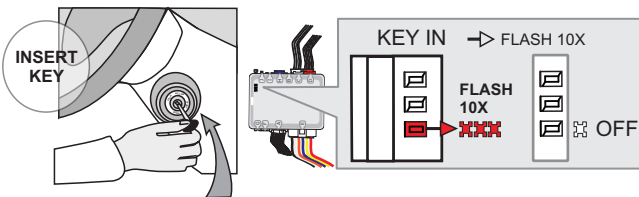

**Insert one functional key into the ignition barrel.**

**Insérez la clé fonctionnelle dans le barillet.**

**DO NOT turn ON the key.**

**Ne tournez pas la clé.**

↳The RED LED will flash rapidly 10x times.  
Key bypass programmed.

↳La DEL ROUGE clignotera 10x fois rapidement.  
Contournement de clé programmé.

*If the LED is solid RED disconnect the 6 Pin connector (Main-Harness) and go back to step 1.*

*Si le DEL est ROUGE solide débranchez le connecteur 6 pins (Connecteur principal) et allez à l'étape 1.*

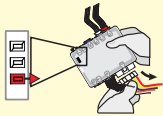

6

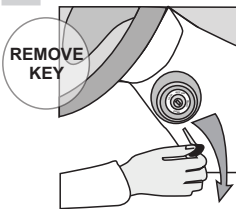

**Remove the key from the ignition barrel.**

**Retirez la clé du barillet d'ignition.**







**The module is now programmed.**

**Le module est programmé.**

Use the remote of the remote starter or security system to test all of the supported features to ensure proper programming.

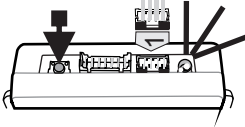
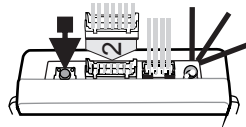
Testez toutes les fonctions supportées sur le véhicule avec la télécommande du démarreur à distance ou du système de sécurité.

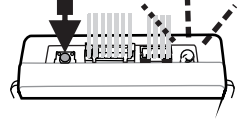
**INT-SL+ PROGRAMMING PROCEDURE CONFIG.2 | PROCÉDURE DE PROGRAMMATION DU INT-SL+ CONFIG.2**

<p><b>1</b></p>  <p>Keep programming button pressed while inserting <b>connector 1</b>.</p> <p>Maintenez le bouton de programmation enfoncé. Insérez le <b>connecteur 1</b> dans le module.</p>	<p><b>2</b></p>  <p>Insert <b>connector 2</b>.</p> <p>Release the programming button when the LED turns ON.</p> <p>Insérez le <b>connecteur 2</b> dans le module.</p> <p>Lorsque la DEL s'allume, relâchez le bouton de programmation.</p>	<p><b>3</b></p>  <p>Press the lock button on the door.</p> <p>Appuyer sur le bouton verrouillage de la porte.</p>	<p><b>4</b></p>  <p>The LED will flash rapidly.</p> <p>La DEL clignote rapidement.</p>	 <p><i>The module is now programmed.</i></p> <p><i>Le module est programmé.</i></p>
--	---	--	---	--

**REMOTE STARTER PROGRAMMING PROCEDURE | PROCÉDURE DE PROGRAMMATION DU DÉMARREUR À DISTANCE**

 REFER TO THE **QUICK INSTALL GUIDE** INCLUDED WITH THE MODULE FOR THE REMOTE STARTER PROGRAMMING.

 RÉFÉREZ-VOUS AU **GUIDE D'INSTALLATION RAPIDE** INCLUS AVEC LE MODULE POUR LA PROGRAMMATION DU DÉMARREUR À DISTANCE.



**REMOTE STARTER FUNCTIONALITY | FONCTIONNALITÉS DU DÉMARREUR À DISTANCE**



All doors must be closed.

Toutes les portes doivent être fermées.



Remote start the vehicle.

Démarrez à distance.



Unlock the doors with the remote-starter remote.

Déverrouillez les portes avec la télécommande du démarreur à distance.

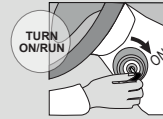

Insert and Turn the key to the Ignition ON/RUN position.

Insérez et tournez la clé à la position "ON/RUN".



Press the brake pedal.

Appuyez sur la pédale de frein.



The vehicle can now be put in to gear and driven.

Vous êtes maintenant prêt à embrayer et prendre la route.



Module label | Étiquette sur le module

### Notice: Updated Firmware and Installation Guides

Updated firmware and installation guides are posted on our web site on a regular basis. We recommend that you update this module to the latest firmware and download the latest installation guide(s) prior to the installation of this product.

### Notice: Mise à jour microprogramme et Guides d'installations

Des mises à jour du Firmware (microprogramme) et des guides d'installation sont mis en ligne régulièrement. Vérifiez que vous avez bien la dernière version logiciel et le dernier guide d'installation avant l'installation de ce produit.

## WARNING

The information on this sheet is provided on an (as is) basis with no representation or warranty of accuracy whatsoever. It is the sole responsibility of the installer to check and verify any circuit before connecting to it. Only a computer safe logic probe or digital multimeter should be used. FORTIN ELECTRONIC SYSTEMS assumes absolutely no liability or responsibility whatsoever pertaining to the accuracy or currency of the information supplied. The installation in every case is the sole responsibility of the installer performing the work and FORTIN ELECTRONIC SYSTEMS assumes no liability or responsibility whatsoever resulting from any type of installation, whether performed properly, improperly or any other way. Neither the manufacturer or distributor of this module is responsible of damages of any kind indirectly or directly caused by this module, except for the replacement of this module in case of manufacturing defects. This module must be installed by qualified technician. The information supplied is a guide only. This instruction guide may change without notice. Visit [www.fortinbypass.com](http://www.fortinbypass.com) to get the latest version.

## MISE EN GARDE

L'information de ce guide est fournie sur la base de représentation (telle quelle) sans aucune garantie de précision et d'exactitude. Il est de la seule responsabilité de l'installateur de vérifier tous les fils et circuits avant d'effectuer les connexions. Seuls une sonde logique ou un multimètre digital doivent être utilisés. FORTIN SYSTÈMES ÉLECTRONIQUES n'assume aucune responsabilité de l'exactitude de l'information fournie. L'installation (dans chaque cas) est la responsabilité de l'installateur effectuant le travail. FORTIN SYSTÈMES ÉLECTRONIQUES n'assume aucune responsabilité suite à l'installation, que celle-ci soit bonne, mauvaise ou de n'importe autre type. Ni le fabricant, ni le distributeur ne se considèrent responsables des dommages causés ou ayant pu être causés, indirectement ou directement, par ce module, excepté le remplacement de ce module en cas de défectuosité de fabrication. Ce module doit être installé par un technicien qualifié. L'information fournie dans ce guide est une suggestion. Ce guide d'instruction peut faire l'objet de changement sans préavis. Consultez le [www.fortinbypass.com](http://www.fortinbypass.com) pour voir la plus récente version.

Copyright © 2006-2018, FORTIN AUTO RADIO INC ALL RIGHTS RESERVED PATENT PENDING



## TECH SUPPORT

Tél: 514-255-HELP (4357)  
1-877-336-7797



## ADDENDUM GUIDE

[www.fortinbypass.com](http://www.fortinbypass.com)

WEB UPDATE | MISE À JOUR INTERNET

