

REGULAR & THAR-ONE-SUB2 INSTALLATION INSTALLATION RÉGULIÈRE, & THAR-ONE-SUB2

 ADDENDUM - SUGGESTED WIRING CONFIGURATION
 ADDENDA - SCHÉMA DE BRANCHEMENT SUGGÉRÉ

Vehicle functions supported in this diagram (functional if equipped) | Fonctions du véhicule supportées dans ce diagramme (fonctionnelles si équipé)

	YEARS ANNÉES	Immobilizer bypass Contournement d'immobilisateur	Lock	Unlock	Arm	Disarm	Trunk (open)	Parking Lights	Tachometer	Door Status	Trunk Status	Hood Status*	Foot-Brake Status	OEM Remote monitoring**
		SUBARU WRX	Push-to-Start	2019-2020	•	•	•	•	•	•	•	•	•	•

**BYPASS FIRMWARE VERSION
VERSION LOGICIELLE CONTOURNEMENT**
84.[11]

MINIMUM

 To add the firmware version and the options, use the **FLASH LINK UPDATER** or **FLASH LINK MOBILE** tool, sold separately.

 Pour ajouter la version logicielle et les options, utilisez l'outil **FLASH LINK UPDATER** ou **FLASH LINK MOBILE**, vendu séparément.

**Program bypass option:
Programmez l'option du contournement:**
**UNIT OPTION
OPTION UNITE**
DESCRIPTION
C1

 OEM Remote status (Lock/Unlock) monitoring
 Suivi des status (Verrouillage/Déverrouillage) de la télécommande d'origine

**Program bypass option
(If equipped with OEM alarm):
Programmez l'option du contournement
(Si équipé d'une alarme d'origine):**
D2

 Unlock before / Lock after (Disarm OEM alarm)
 Déverrouille avant / Verrouille après (Désarme l'alarme d'origine)

D5

 Lock after start
 Verrouillage après le démarrage

D6

 Push-to-Start
 Push-to-Start

**IF THE VEHICLE IS NOT EQUIPPED
WITH FUNCTIONAL HOOD PIN:
SI LE VÉHICULE N'EST PAS ÉQUIPÉ
D'UN CONTACT DE CAPOT FONCTIONNEL:**
A11
**OFF
NON**

 Hood trigger (Output Status).
 Contact de capot (état de sortie).

**Program remote starter option for R.S.
OEM REMOTE STAND ALONE:
Programmez l'option démarreur à distance pour TÉLÉCOMMANDE D'ORIGINE STAND ALONE:**
**FUNCTION
FONCTION**
MODE
DESCRIPTION
38
2

 Enable
 Press 3x Lock to remote start with the OEM remote.
 Activé
 Appuyez x3 sur Verrouille de la télécommande d'origine pour démarrer à distance le véhicule.

NOTES
****OEM Remote monitoring**

The vehicles OEM remote will remain functional when the vehicle is running, however, the intelligent access key will not unlock the doors when the vehicle is running.

La télécommande d'origine du véhicule sera fonctionnelle pendant que le véhicule est en marche, toutefois, le déverrouillage des portes par la clé d'accès Intelligente ne sera pas fonctionnel.

MANDATORY INSTALL | INSTALLATION OBLIGATOIRE
*** HOOD
PIN
CONTACT
DE CAPOT**

HOOD STATUS: THE HOOD PIN SWITCH (INCLUDED) MUST BE INSTALLED IF THE VEHICLE CAN BE REMOTE STARTED WITH THE HOOD OPEN, SET FUNCTION A11 TO OFF.
STATUT DE CAPOT: LE CONTACT DE CAPOT (INCLUS), DOIT ÊTRE INSTALLÉ SI LE VÉHICULE PEUT DÉMARRER À DISTANCE, LORSQUE LE CAPOT EST OUVERT, PROGRAMMEZ LA FONCTION A11 À NON.

A11
**OFF
NON**
**SECURITY STICKER
AUTOCOLLANT DE
SÉCURITÉ**

 Included
 Inclus

Notice: the installation of safety elements are mandatory. The hood pin and the sticker are essential security elements and must be installed.
Notice: l'installation des éléments de sécurité est obligatoire. Le contact de capot et l'autocollant de sécurité sont des éléments de sécurité essentiels et doivent absolument être installés.

THIS MODULE MUST BE INSTALLED BY A QUALIFIED TECHNICIAN. A WRONG CONNECTION CAN CAUSE PERMANENT DAMAGE TO THE VEHICLE.

CE MODULE DOIT ÊTRE INSTALLÉ PAR UN TECHNICIEN QUALIFIÉ, TOUTE ERREUR DANS LES BRANCHEMENTS PEUT OCCASIONNER DES DOMMAGES PERMANENTS AU VÉHICULE.

NOTES

	Parts required (Not included)	Pièce(s) requise(s) (Non incluse(s))	PAGE
--	--------------------------------------	---	-------------

WIRE TO WIRE DIAGRAM | SCHÉMA DE BRANCHEMENTS FIL À FIL

	AUTOMATIC TRANSMISSION TRANSMISSION AUTOMATIQUE		4
	MANUAL TRANSMISSION TRANSMISSION MANUELLE	1x 1 Amp. Diodes	1x Diodes 1 Amp. 5

THARNNESS DIAGRAM | SCHÉMA DE BRANCHEMENTS HARNAIS EN T

THARNNESS THAR-ONE-SUB2 FOR CANADIAN VEHICLE POUR VÉHICULE CANADIEN	AUTOMATIC TRANSMISSION TRANSMISSION AUTOMATIQUE			7
	MANUAL TRANSMISSION TRANSMISSION MANUELLE	1x THAR-ONE-SUB2	1x THAR-ONE-SUB2	
THARNNESS THAR-ONE-SUB2 FOR US VEHICLE POUR VÉHICULE AMÉRICAIN	AUTOMATIC TRANSMISSION TRANSMISSION AUTOMATIQUE			8
	MANUAL TRANSMISSION TRANSMISSION MANUELLE	1x THAR-ONE-SUB2	1x THAR-ONE-SUB2	

DESCRIPTION | DESCRIPTION

④ Clutch switch
Commutateur de l'embrayage

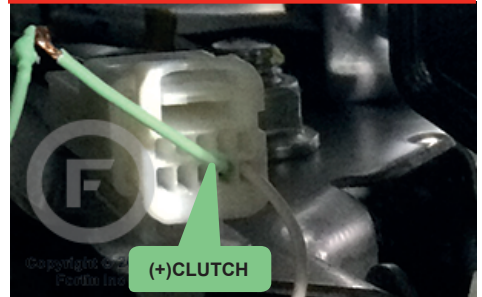

① ECM next to air cleaner assembly, under the hood
ECM à côté du filtre à air, sous le capot

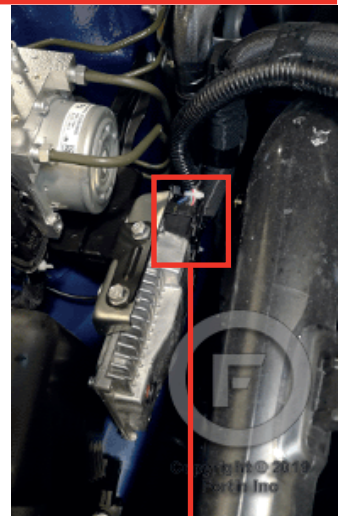

② At Smart key module
Au Module de la clé intelligente

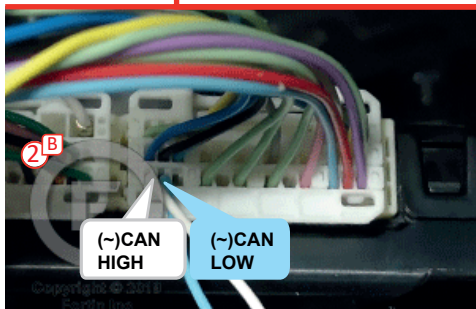
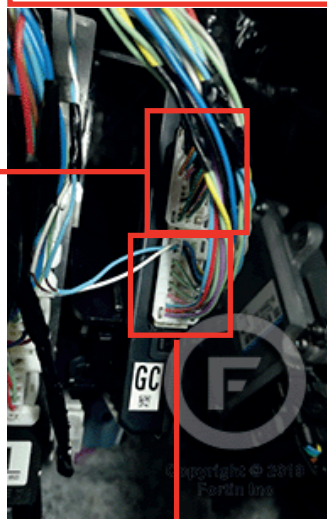

③ At parking lights switch
Au commutateur des feux de stationnement

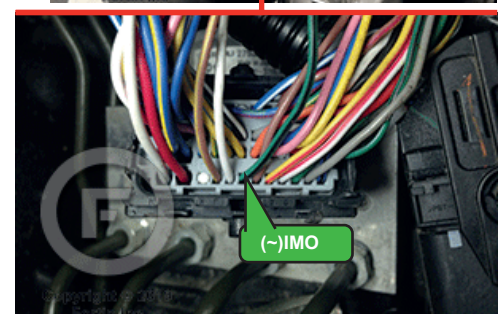
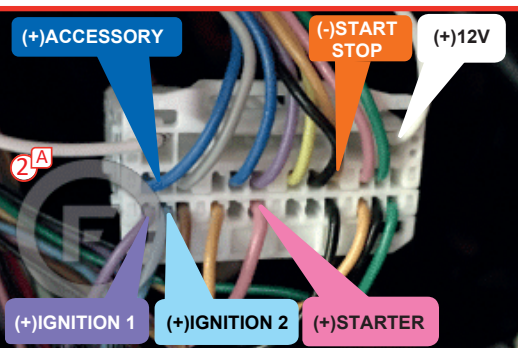
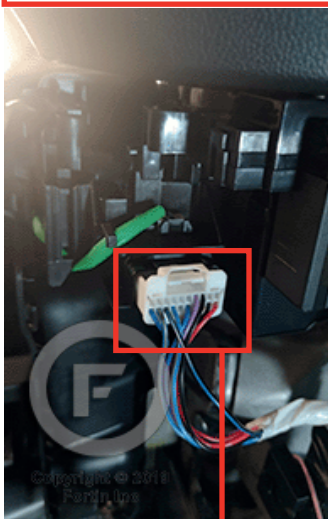

AUTOMATIC TRANSMISSION WIRING CONNECTION | SCHÉMA DE BRANCHEMENT TRANSMISSION AUTOMATIQUE

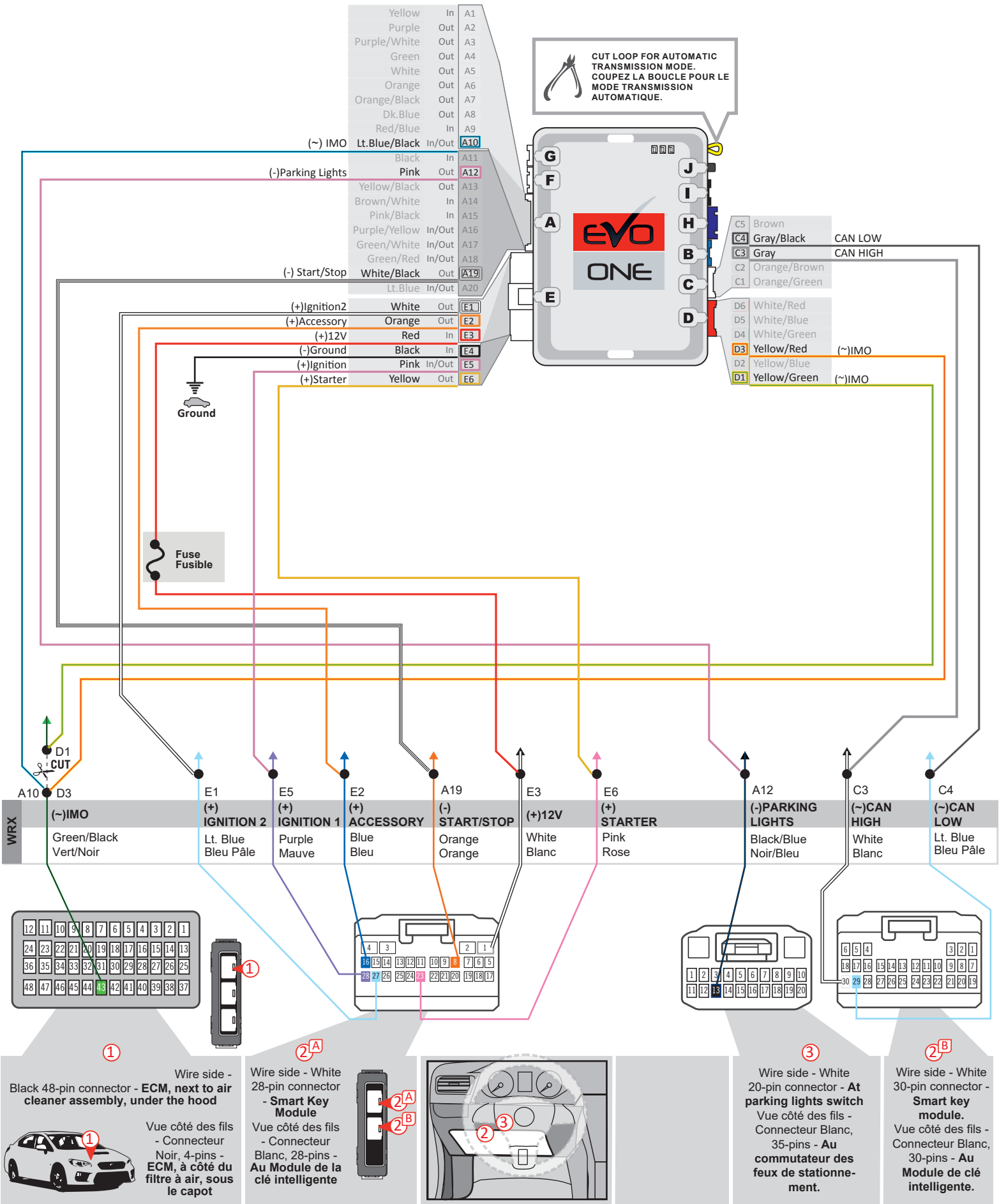

MANUAL TRANSMISSION WIRING CONNECTION | SCHÉMA DE BRANCHEMENT TRANSMISSION MANUELLE

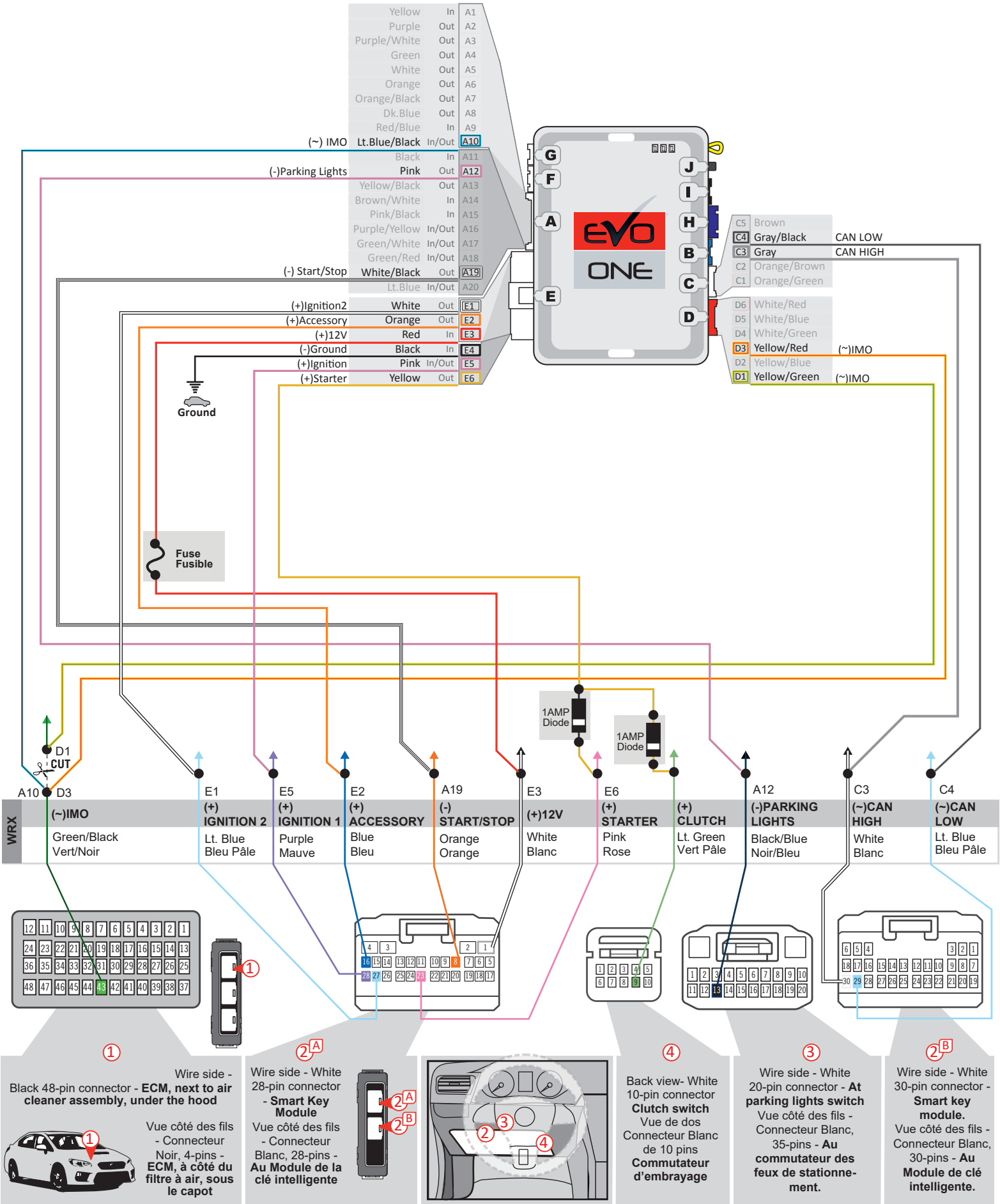

DESCRIPTION | DESCRIPTION



① ECM next to air cleaner assembly, under the hood
ECM à côté du filtre à air, sous le capot

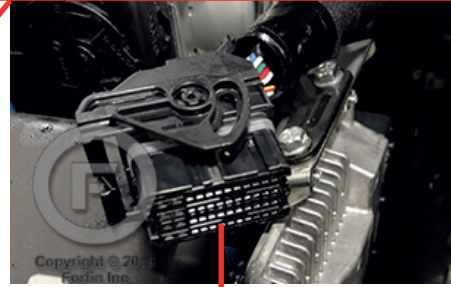

THAR-ONE-SUB2 | T-HARNESS - AUTOMATIC & MANUAL TRANSMISSION | T-HARNAIS - TRANSMISSION AUTOMATIQUE ET MANUELLE

**CANADIAN VEHICLE
VÉHICULE CANADIEN**

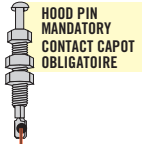

Yellow	In	A1
Purple	Out	A2
Purple/White	Out	A3
Green	Out	A4
White	Out	A5
Orange	Out	A6
Orange/Black	Out	A7
Dk.Blue	Out	A8
Red/Blue	In	A9
Lt.Blue/Black	In/Out	A10
Black	In	A11
Pink	Out	A12
Yellow/Black	Out	A13
Brown/White	In	A14
Pink/Black	In	A15
Purple/Yellow	In/Out	A16
Green/White	In/Out	A17
Green/Red	In/Out	A18
White/Black	Out	A19
Lt.Blue	In/Out	A20
White	Out	E1
Orange	Out	E2
Red	In	E3
Black	In	E4
Pink	In/Out	E5
Yellow	Out	E6

CUT LOOP FOR AUTOMATIC TRANSMISSION MODE. COUPEZ LA BOUCLE POUR LE MODE TRANSMISSION AUTOMATIQUE.

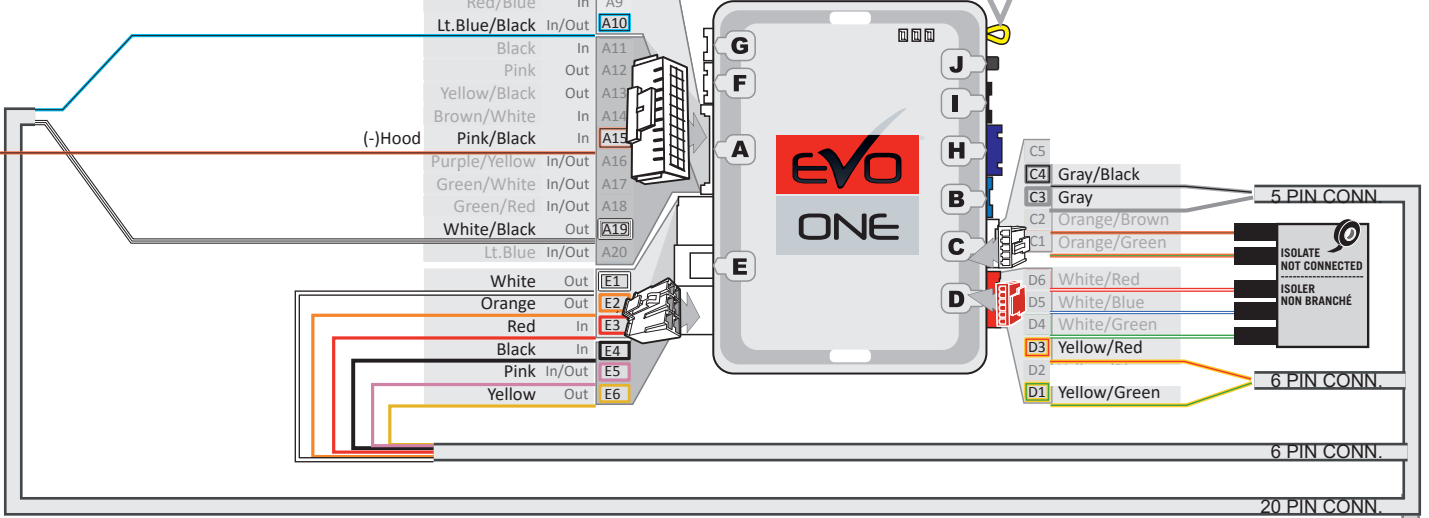

T-HARNESS - HARNAIS EN T
THAR-ONE-SUB2



ISOLATE NOT CONNECTED / ISOLER NON BRANCHÉ

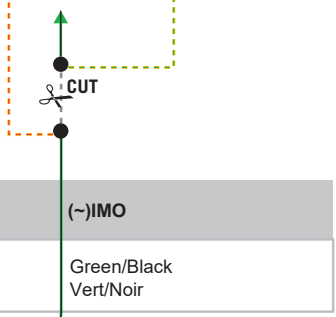

28-pin White connector at Certification ECU, behind fuse box

Connecteur Blanc de 28-pins au ECU Certification, derrière la boîte à fusibles.

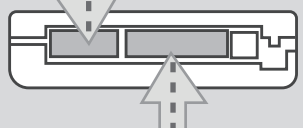

30-pin White connector at Certification ECU, behind fuse box

Connecteur Blanc de 30-pins au ECU Certification, derrière la boîte à fusibles.

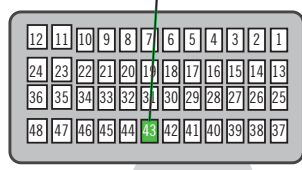
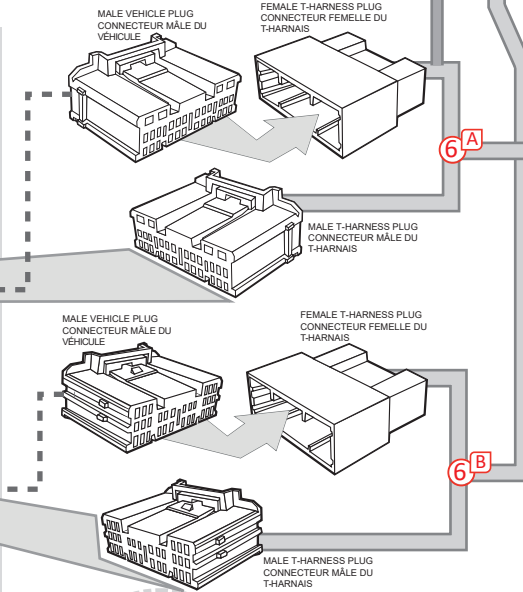

Wire side - Black 48-pin connector - ECM, next to air cleaner assembly, under the hood

Vue côté des fils - Connecteur Noir, 4-pins - ECM, à côté du filtre à air, sous le capot

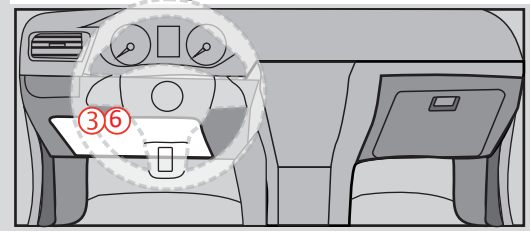

THAR-ONE-SUB2 | T-HARNESS - AUTOMATIC & MANUAL TRANSMISSION | T-HARNAIS - TRANSMISSION AUTOMATIQUE ET MANUELLE

**US VEHICLE
VÉHICULE AMÉRICAIN**

**HOOD PIN
MANDATORY
CONTACT CAPOT
OBLIGATOIRE**

Yellow	In	A1
Purple	Out	A2
Purple/White	Out	A3
Green	Out	A4
White	Out	A5
Orange	Out	A6
Orange/Black	Out	A7
Dk.Blue	Out	A8
Red/Blue	In	A9
Lt.Blue/Black	In/Out	A10
Black	In	A11
Pink	Out	A12
Yellow/Black	Out	A13
Brown/White	In	A14
Pink/Black	In	A15
Purple/Yellow	In/Out	A16
Green/White	In/Out	A17
Green/Red	In/Out	A18
White/Black	Out	A19
Lt.Blue	In/Out	A20
White	Out	E1
Orange	Out	E2
Red	In	E3
Black	In	E4
Pink	In/Out	E5
Yellow	Out	E6

**CUT LOOP FOR AUTOMATIC
TRANSMISSION MODE.
COUPEZ LA BOUCLE POUR LE
MODE TRANSMISSION
AUTOMATIQUE.**

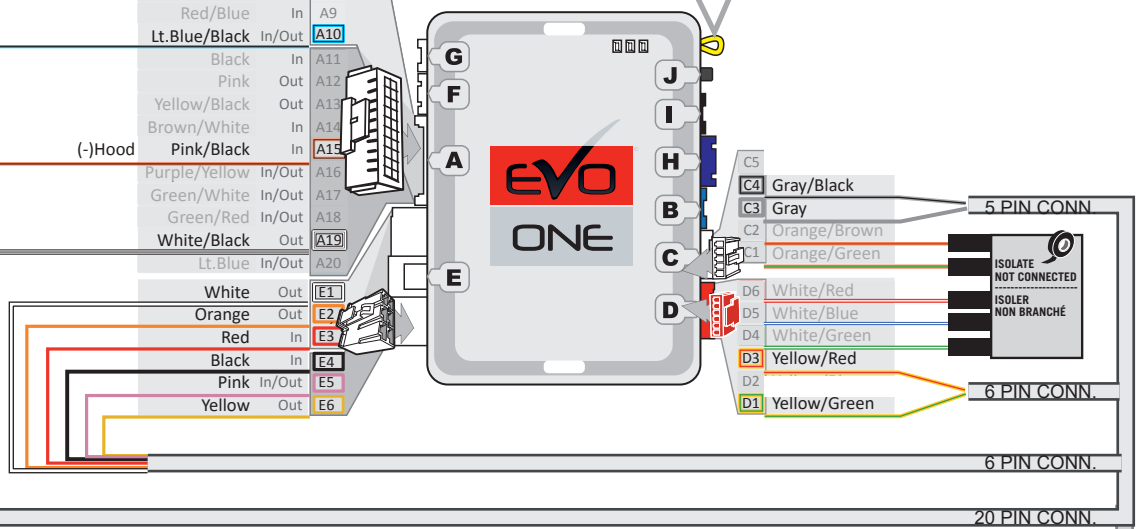

T-HARNESS - HARNAIS EN T
THAR-ONE-SUB2

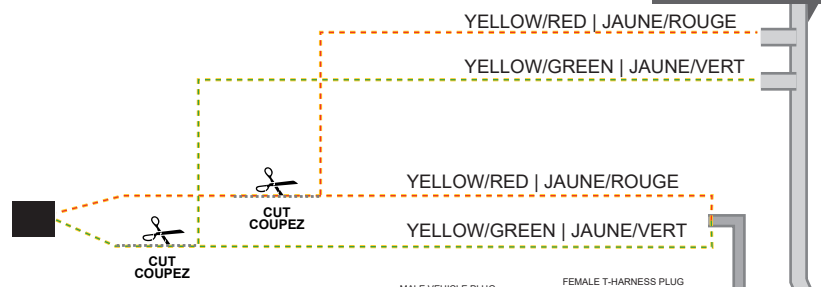

**28-pin White connector at
Certification ECU, behind
fuse box**

Connecteur Blanc de
28-pins au ECU Certifica-
tion, derrière la boîte à
fusibles.

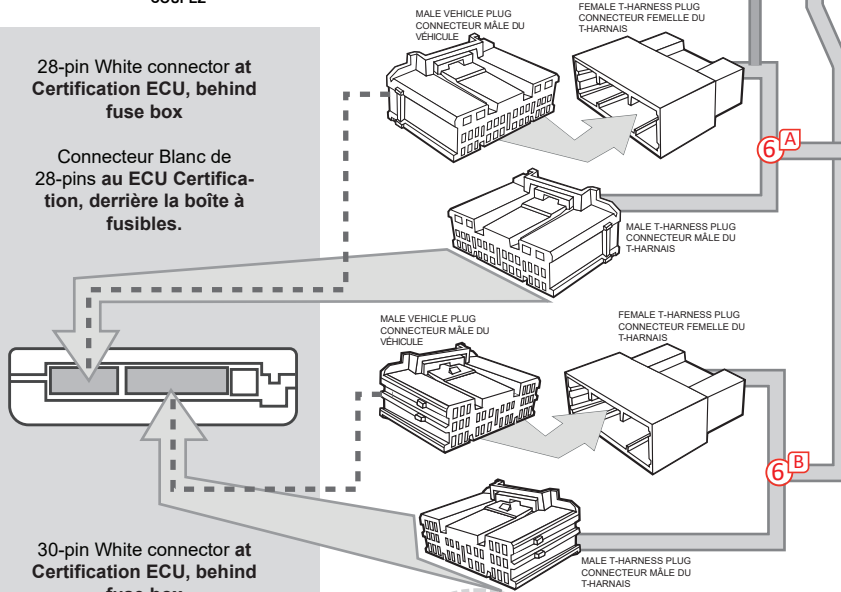

**30-pin White connector at
Certification ECU, behind
fuse box**

Connecteur Blanc de
30-pins au ECU Certifica-
tion, derrière la boîte à
fusibles.

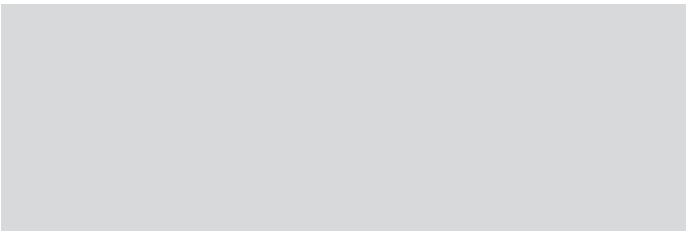
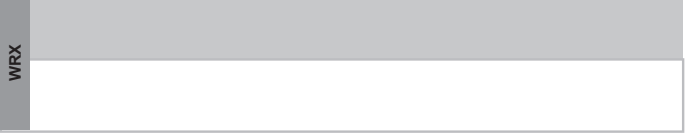
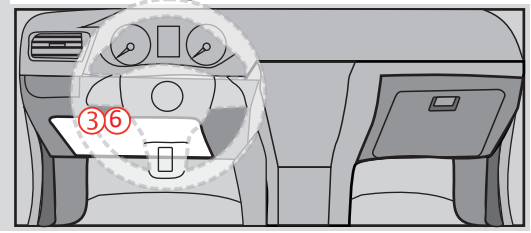

WRX

DCRYPTOR PROGRAMMING PROCEDURE | PROCÉDURE DE PROGRAMMATION AVEC DCRYPTOR



Parts required (not included) Pièces requises (non incluses)

- 1x **FLASH LINK UPDATER,**
- 1x **FLASH LINK MANAGER**
SOFTWARE | PROGRAMME
- 1x Microsoft Windows Computer with Internet connection
Ordinateur Microsoft Windows avec connection Internet

**OR
OU**

- 1x **FLASH LINK MOBILE**
- 1x **FLASH LINK MOBILE APP**
- Smartphone Android or iOS with Internet connection
(Internet provider charges may apply)
Téléphone Intelligent Android ou iOS avec connection
Internet (des frais du fournisseur Internet peuvent s'appliquer)

BEFORE PROGRAMMING SET THE UNIT OPTIONS AND SAVE. | AVANT LA PROGRAMMATION CONFIGURER LES OPTIONS DE L'UNITÉ ET SAUVEGARDER.

1

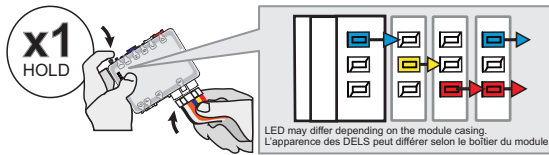

Press and hold the programming button:
Connect the 6-PIN Main harness (White connector).

↳ The Blue, Red, Yellow and Blue & Red LEDs will alternatively illuminate.

Appuyez et maintenir le bouton de programmation enfoncé:
Branchez le harnais Blanc à 6-Pins (connecteur Blanc)

↳ Les DELs Bleue, Rouge, Jaune et Bleue & Rouge s'illumineront alternativement.

2

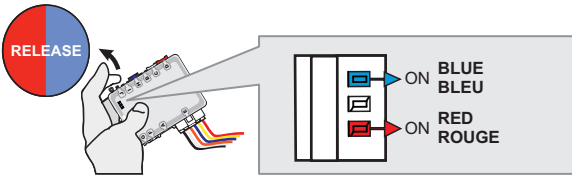

Release the programming button when the LED's are BLUE & RED.

If the LED's are not solid BLUE and RED **disconnect** the 6-Pin connector (Main-Harness) and go back to step 1.

Relâchez le bouton de programmation quand les DELs sont BLEU et ROUGE.

Si le DEL ne sont pas BLEU et ROUGE **débranchez** le connecteur 6 pins (Connecteur principal) et **allez** au début de l'étape 1.

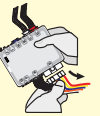

3

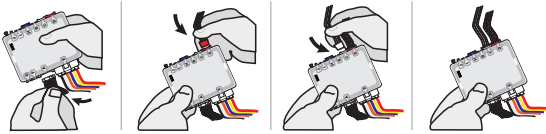

Insert the required remaining connectors.

Insérez les connecteurs requis restants.

4

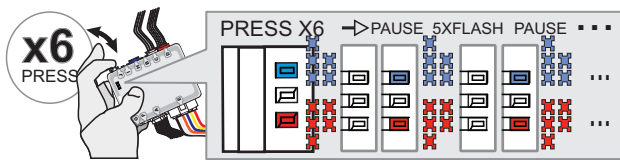

Press and release the programming button six time (6x).

↳ The RED and BLUE LED will flash 5 times each second.

Appuyez et relâchez 6 fois le bouton de programmation.

↳ Les DELs ROUGE et BLEUE clignotent 5 fois chaque seconde.

5

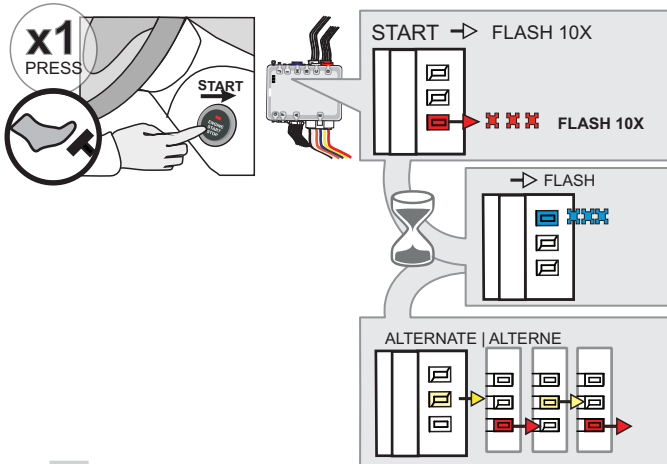

Start the engine :
Press the brake pedal.
Press the Push-to-Start button to start the engine.

↳ The RED LED will flash rapidly 10x times.
Key bypass programmed.

↳ Wait for the BLUE LED will flash rapidly.

↳ Wait for the YELLOW and RED LED will alternate.

Démarez le moteur:
Appuyez sur la pédale de frein.
Appuyez 1 fois sur le bouton démarrage (Push-to-Start) pour démarrer le moteur.

↳ La DEL ROUGE clignotera 10x fois rapidement.
Contournement de clé programmé.

↳ Attendre que la DEL BLEUE clignote rapidement.

↳ Attendre que les DELs JAUNE et ROUGE alternent.

6

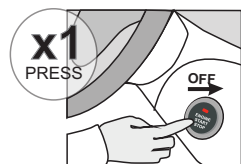

Stop the engine:
Press the Push-to-Start button once to turn off the ignition.

Éteindre le moteur :
Appuyez 1 fois sur le bouton démarrage (Push-to-Start) pour éteindre l'ignition.

KEY BYPASS PROGRAMMING PROCEDURE 2/2 | PROCÉDURE DE PROGRAMMATION CONTOURNEMENT DE CLÉ 2/2

7

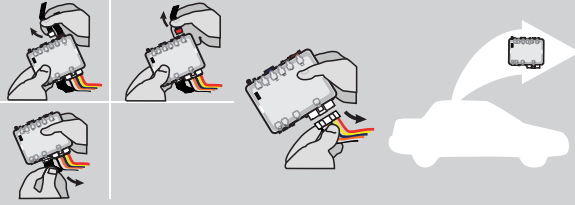

Disconnect all connectors and after the 6-Pin (Main-Harness) or the 4-Pin Data-link connector.

Débranchez tous les connecteurs et ensuite le connecteur 6-pins (Connecteur principal) ou le connecteur 4-pins (Data-Link).

8

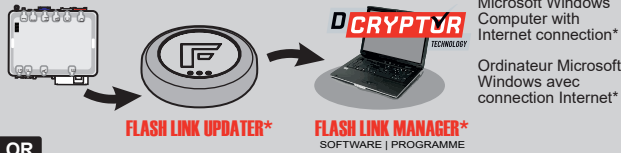

OR
OU

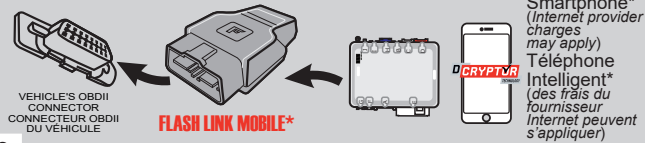

Use the tool:
FLASH LINK UPDATER or
FLASH LINK MOBILE
to visit the DCryptor menu.

Utilisez l'outil:
FLASH LINK UPDATER ou
FLASH LINK MOBILE
pour visiter le menu DCryptor.

*Parts required (not included) *Pièces requises (non incluses)

9

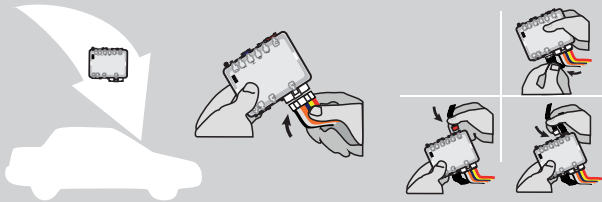

AFTER DCRYPTOR PROGRAMMING COMPLETED
Go back to the vehicle and reconnect the 6-Pin (Main-Harness) or the 4-pins (Data-Link) connector and after all the remaining connector.

APRÈS LA PROCÉDURE DE PROGRAMMATION DCRYPTOR COMPLÉTÉE : **retournez** au véhicule et **rebranchez** le connecteur 6-pins (Connecteur principal) ou le 4-pins (Data-Link) et après tous les connecteurs.



*The module is now programmed.
Le module est programmé.*



REMOTE STARTER / ALARM VERIFICATION PROCEDURE | PROCÉDURE DE VÉRIFICATION DU DÉMARREUR À DISTANCE / ALARME

Test the remote starter. Remote start the vehicle.
Testez le démarreur à distance. Démarrez le véhicule à distance.



REMOTE STARTER PROGRAMMING PROCEDURE | PROCÉDURE DE PROGRAMMATION DU DÉMARREUR À DISTANCE

 REFER TO THE **QUICK INSTALL GUIDE** INCLUDED WITH THE MODULE FOR THE REMOTE STARTER PROGRAMMING.

 RÉFÉREZ-VOUS AU **GUIDE D'INSTALLATION RAPIDE** INCLUS AVEC LE MODULE POUR LA PROGRAMMATION DU DÉMARREUR À DISTANCE.

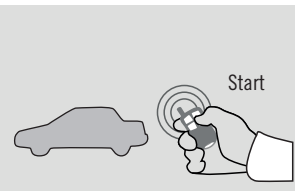
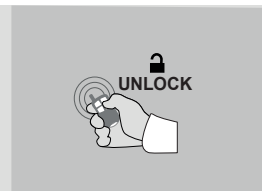
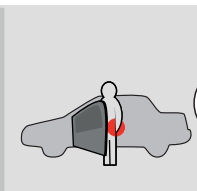

REMOTE STARTER FUNCTIONALITY | FONCTIONNALITÉS DU DÉMARREUR À DISTANCE

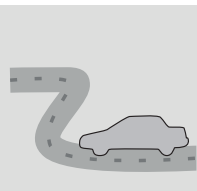
 <p>Start</p> <p>All doors must be closed. Remote start the vehicle.</p> <p>Toutes les portes doivent être fermées Démarrez à distance.</p>	 <p>UNLOCK</p> <p>Unlock the doors with either: The OEM remote Or The remote-starter</p> <p>Déverrouillez les portes avec soit: la télécommande d'origine ou la télécommande du démarreur à distance</p>	 <p>x1 PRESS</p> <p>Enter the vehicle with the SMART-KEY.</p> <p>Entrez dans le véhicule avec la clé intelligente (SMART-Key) sur vous</p>	 <p>DO NOT PRESS THE BRAKE PEDAL. Press and release the Push-to-Start button once.</p> <p>NE PAS APPUYER LA PÉDALE DE FREIN. Appuyez et relâchez une fois le bouton démarrage (Push-to-Start).</p>	 <p>FLASH x1</p> <p>Wait for the orange led on the Push-to-Start button to flash once.</p> <p>Attendez que la DEL orange du bouton démarrage s'allume et s'éteigne.</p>	 <p>Press the brake pedal. The vehicle can now be put in to gear and driven. If the Smart-Key is not detected the vehicle will shut down.</p> <p>Appuyez sur la pédale de frein. Vous êtes maintenant prêt à embrayer et prendre la route. Si la clé intelligente n'est pas détectées le véhicule s'éteindra.</p>
---	--	--	---	---	--



Module label | Étiquette sur le module

Notice: Updated Firmware and Installation Guides

Updated firmware and installation guides are posted on our web site on a regular basis. We recommend that you update this module to the latest firmware and download the latest installation guide(s) prior to the installation of this product.

Notice: Mise à jour microprogramme et Guides d'installations

Des mises à jour du Firmware (microprogramme) et des guides d'installation sont mis en ligne régulièrement. Vérifiez que vous avez bien la dernière version logiciel et le dernier guide d'installation avant l'installation de ce produit.

WARNING

The information on this sheet is provided on an (as is) basis with no representation or warranty of accuracy whatsoever. It is the sole responsibility of the installer to check and verify any circuit before connecting to it. Only a computer safe logic probe or digital multimeter should be used. FORTIN ELECTRONIC SYSTEMS assumes absolutely no liability or responsibility whatsoever pertaining to the accuracy or currency of the information supplied. The installation in every case is the sole responsibility of the installer performing the work and FORTIN ELECTRONIC SYSTEMS assumes no liability or responsibility whatsoever resulting from any type of installation, whether performed properly, improperly or any other way. Neither the manufacturer or distributor of this module is responsible of damages of any kind indirectly or directly caused by this module, except for the replacement of this module in case of manufacturing defects. This module must be installed by qualified technician. The information supplied is a guide only. This instruction guide may change without notice. Visit www.fortinbypass.com to get the latest version.

MISE EN GARDE

L'information de ce guide est fournie sur la base de représentation (telle quelle) sans aucune garantie de précision et d'exactitude. Il est de la seule responsabilité de l'installateur de vérifier tous les fils et circuits avant d'effectuer les connexions. Seuls une sonde logique ou un multimètre digital doivent être utilisés. FORTIN SYSTÈMES ÉLECTRONIQUES n'assume aucune responsabilité de l'exactitude de l'information fournie. L'installation (dans chaque cas) est la responsabilité de l'installateur effectuant le travail. FORTIN SYSTÈMES ÉLECTRONIQUES n'assume aucune responsabilité suite à l'installation, que celle-ci soit bonne, mauvaise ou de n'importe autre type. Ni le fabricant, ni le distributeur ne se considèrent responsables des dommages causés ou ayant pu être causés, indirectement ou directement, par ce module, excepté le remplacement de ce module en cas de défaut de fabrication. Ce module doit être installé par un technicien qualifié. L'information fournie dans ce guide est une suggestion. Ce guide d'instruction peut faire l'objet de changement sans préavis. Consultez le www.fortinbypass.com pour voir la plus récente version.

Copyright © 2006-2018, FORTIN AUTO RADIO INC ALL RIGHTS RESERVED PATENT PENDING



TECH SUPPORT

Tél: 514-255-HELP (4357)
1-877-336-7797



ADDENDUM GUIDE

www.fortinbypass.com

WEB UPDATE | MISE À JOUR INTERNET

